

KENT 

CATALOGUE 2023

Premium products for a wide variety of applications across the automotive, industrial and marine sectors.



CONTENTS

Abrasives



Additives



Adhesives



Adhesive Tapes



Air Conditioning



Body Fillers



Body Seam Sealers



Brake Servicing



Cleaning Agents



Electrical Repair

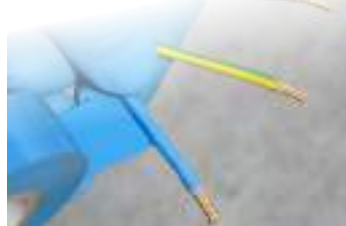

Gasketing



Health & Safety



Lubricants & Penetrants



Masking



Plastic Repair & Refinishing



Polishes



Primers & Coatings



Specialist Products



Tools, Accessories & Consumables



Valeting



Welding



Windscreen



ABRASIVES



FINECUT ABRASIVE DISCS

Specially developed for surface preparation / finishing prior to polishing.

- ✓ Improved topcoat
- ✓ Perfect for contoured surfaces, corners, sharp edges

| | | |
|-----------------------------------|-------|-----------|
| Part number: A1346 (Finecut 2000) | 150mm | Box of 20 |
| Part number: A1347 (Finecut 3000) | 150mm | Box of 20 |
| Part number: A1348 (Finecut 4000) | 150mm | Box of 20 |



FINECUT V2

Finecut V2 discs made of fabric laminated with flexible foam rubber.

- ✓ Highly breathable backing allows complete dust extraction
- ✓ Specially designed for matting and shading paints
- ✓ Ideal for obtaining an even finish - both dry and wet

| | | |
|------------------------------------------------|------|-----------|
| Part number: A1471 - Finecut V2 P1000 (Purple) | 75mm | 10 Sheets |
| Part number: A1472 - Finecut V2 P2000 (Orange) | 75mm | 10 Sheets |
| Part number: A1473 - Finecut V2 P3000 (Red) | 75mm | 10 Sheets |
| Part number: A1474 - Finecut V2 P4000 (Green) | 75mm | 10 Sheets |



SUPERIOR QUALITY MATTING DISCS

A range of 4 sponge backed abrasive discs for fine finishing.

- ✓ Extra long life
- ✓ Unique fixing system
- ✓ Allow for substrate irregularities and body contours

| | | |
|---------------------------------|------------|-----------|
| Part number: A1187 (Fine) | P800 | Box of 15 |
| Part number: A1188 (Super Fine) | P1200-1500 | Box of 15 |
| Part number: A1189 (Micro Fine) | P1500-2000 | Box of 15 |
| Part number: A1190 (Ultra Fine) | P2000-2500 | Box of 15 |



SOFT INTERFACE PADS

Fit between a backing plate and any multi-hole machine sanding discs.

- ✓ Ideal for curved and irregular surfaces
- ✓ Keep the sanding disc perfectly in position
- ✓ Long lasting grip to the back-up pad

| | | |
|--------------------|------------|---------|
| Part number: A1351 | 150mm/5mm | 1 piece |
| Part number: A1352 | 150mm/10mm | 1 piece |
| Part number: A1354 | 77mm/10mm | 1 piece |



DURALITE ABRASIVE DISCS - 150mm

Ideal for the sanding of hard, clogging materials such as body fillers, gel coat, anti-fouling, wood, plastics and fibre glass. A high quality, durable disc with aggressive cutting properties.

- ✓ Artificial Corundum grains ensure long life
- ✓ Zinc Stearate anti-clogging agent
- ✓ Self fixing and re-usable

| | | |
|--------------------|-------|------------|
| Part number: A1330 | P60 | Box of 50 |
| Part number: A1289 | P80 | Box of 100 |
| Part number: A1290 | P120 | Box of 100 |
| Part number: A1291 | P150 | Box of 100 |
| Part number: A1292 | P180 | Box of 100 |
| Part number: A1293 | P220 | Box of 100 |
| Part number: A1294 | P240 | Box of 100 |
| Part number: A1295 | P320 | Box of 100 |
| Part number: A1296 | P400 | Box of 100 |
| Part number: A1455 | P500 | Box of 100 |
| Part number: A1298 | P600 | Box of 100 |
| Part number: A1299 | P800 | Box of 100 |
| Part number: A1331 | P1000 | Box of 100 |
| Part number: A1300 | P1200 | Box of 100 |
| Part number: A1332 | P1500 | Box of 100 |
| Part number: A1301 | P2000 | Box of 100 |



DURALITE ABRASIVE DISCS - 75mm

Ideal for the sanding of hard, clogging materials such as body fillers, gel coat, anti-fouling, wood, plastics and fibre glass. A high quality, durable disc with aggressive cutting properties.

- ✓ Artificial Corundum grains ensure long life
- ✓ Zinc Stearate anti-clogging agent
- ✓ Self fixing and re-usable

| | | |
|--------------------|-------|-----------|
| Part number: A1335 | P80 | Box of 50 |
| Part number: A1336 | P120 | Box of 50 |
| Part number: A1337 | P180 | Box of 50 |
| Part number: A1338 | P240 | Box of 50 |
| Part number: A1339 | P320 | Box of 50 |
| Part number: A1340 | P400 | Box of 50 |
| Part number: A1341 | P500 | Box of 50 |
| Part number: A1342 | P600 | Box of 50 |
| Part number: A1345 | P1500 | Box of 50 |



WHITE LINE ABRASIVE DISCS

A medium quality, aggressive cut abrasive with anti-clog properties.

- ✓ Zinc Stearate anti-clogging agent
- ✓ Suit most commonly used extraction systems
- ✓ Self-fixing and re-usable

| | | |
|--------------------|------|------------|
| Part number: A1333 | P40 | Box of 50 |
| Part number: A1334 | P60 | Box of 50 |
| Part number: A1201 | P80 | Box of 100 |
| Part number: A1203 | P120 | Box of 100 |
| Part number: A1204 | P150 | Box of 100 |
| Part number: A1205 | P180 | Box of 100 |
| Part number: A1206 | P220 | Box of 100 |
| Part number: A1207 | P240 | Box of 100 |
| Part number: A1208 | P280 | Box of 100 |
| Part number: A1209 | P320 | Box of 100 |
| Part number: A1210 | P400 | Box of 100 |
| Part number: A1211 | P500 | Box of 100 |
| Part number: A1212 | P600 | Box of 100 |



NYLON FINISHING ROLL

Used wherever a consistent keyed surface is required. High quality and versatile.

- ✓ High quality grain gives consistent cutting action
- ✓ Structure allows for fine keying
- ✓ Can be easily folded into difficult drip channels etc

| | | |
|--------------------------------|-----------|------------------|
| Part number: A1464 (Maroon) | P320-400 | 115mm x 10m roll |
| Part number: A1465 (Dark Grey) | P800-1000 | 115mm x 10m roll |



WHITE LINE ABRASIVE SOFT ROLL

A foam backed 115mm x 25m roll. Medium quality, aggressive cut abrasive with anti-clog properties.

- ✓ Artificial Corundum grains ensure long life
- ✓ Zinc Stearate anti-clogging agent
- ✓ Foam backing

| | | |
|--------------------|------|------------------|
| Part number: A1255 | P180 | 115mm x 25m roll |
| Part number: A1256 | P240 | 115mm x 25m roll |
| Part number: A1257 | P320 | 115mm x 25m roll |
| Part number: A1258 | P400 | 115mm x 25m roll |
| Part number: A1260 | P600 | 115mm x 25m roll |
| Part number: A1261 | P800 | 115mm x 25m roll |



DURALITE SOFT ROLL (PRE-CUT)

A foam backed 115mm x 25m roll. A high quality, aggressive cut abrasive with anti-clog properties.

- ✓ Ceramic Coated Aluminum Oxide – Smooth final finishes
- ✓ Double stearate coating – Best anti-clogging properties
- ✓ Pre-cut roll – Easy removal of sheets

| | | |
|--------------------|-------|------------------|
| Part number: A1459 | P800 | 115mm x 25m roll |
| Part number: A1463 | P1000 | 115mm x 25m roll |



SOFT PAD (ONE SIDED) SPONGE

A range of four sponge abrasive pads for fine, hand finishing.

- ✓ Will not clog or gum
- ✓ Does not scratch
- ✓ Allows for substrate irregularities and body contours

| | | |
|---------------------------------|------------|-----------|
| Part number: A1270 (Medium) | P600 | Box of 20 |
| Part number: A1271 (Fine) | P800 | Box of 20 |
| Part number: A1272 (Super Fine) | P1200-1500 | Box of 20 |
| Part number: A1273 (Micro Fine) | P1500-2000 | Box of 20 |



150MM DISC MANUAL PADS

Perfect for using 150mm discs on parts that cannot be reached by machine, for example due to high panel curvature. The soft (orange) pad is well suited to filler shade sanding, clear matting and electrophoresis sanding. The standard (yellow) pad is ideal for rounded panels and general work.

- ✓ Suitable for any abrasive disc
- ✓ Ultra-fine special grip Velcro
- ✓ Quick disc centering

| | | |
|----------------------------------------|-------|---------|
| Part number: A1237 (Soft / Orange) | 150mm | 1 piece |
| Part number: A1238 (Standard / Yellow) | 150mm | 1 piece |



RECTANGULAR MANUAL PAD

Ideal for areas that cannot be reached by machine, for example due to high panel curvature. Can also be used for tight panel intersections.

- ✓ Special grip Velcro suitable for Hook-It or Stick-It systems
- ✓ Ideal for working in small areas
- ✓ Suitable for all industries, even intensive use

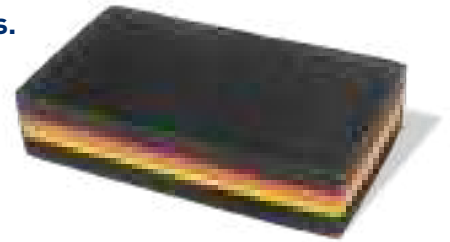

Part number: A1240 125x70x30mm 1 piece

UNIVERSAL BACK-UP PADS

For roto-orbital pneumatic or electric sanders.

- ✓ Ultra-fine special grip Velcro suitable for hook or stick systems
- ✓ Balanced air flow means excellent suction in any orientation
- ✓ 15 hole design makes it compatible with most systems



Part number: A1234 (Bolts and Fittings)
Part number: A1235 (Standard) 12mm 1 piece

MINI AIR SANDER / POLISHER 75MM

Powerful air sander/ polisher with orbital motions and low air consumption (includes back-up pad, screwdriver and manual).

- ✓ Free motor speed
- ✓ Easy to handle
- ✓ Versatile and adapts to every surface preparation



Part number: A1450 (Sander / Polisher) 75mm 1 piece

75MM PALM AIR SANDER

A powerful air sander with orbital motions and low air consumption. Use with its own portable dust bag, central vacuum system or stand-alone.

- ✓ Direct hook-up to a central system or own dust bag
- ✓ Adjustable motor speed
- ✓ Operating pressure 90psi (6.3 kg/cm²)



Part number: A1371 (Palm Air Sander) 75mm 1 piece
Part number: A1373 (Lubricant) 1 piece

CARBON BLOCK KIT

Perfect for the quick removal of paint defects, blemishes, swirls, staining and 'orange peel' effects.

- ✓ High reusability and long life
- ✓ Kit includes cleaning block and waterproof storage tub



| | | |
|--------------------------|-------|---------|
| Part number: 85626 (Kit) | | Tub |
| Part number: 85704 | P800 | 1 piece |
| Part number: 85647 | P1500 | 1 piece |
| Part number: 85648 | P3000 | 1 piece |

ABRAPREP

One-step water based abrasive cleaning and preparation system for preparation of panels for painting, for blending-in of new paintwork when carrying out local repairs and for clear coat preparation.

- ✓ 3-in-1 saves time - Triple-action: abrades, cleans and completely degreases
- ✓ Consistent even key - Enhances coating adhesion
- ✓ Easy to apply - Works fast
- ✓ Corners and crevices - Uniform matting and cleaning action
- ✓ Water-based - Easy to wipe off and no residues
- ✓ No problems - Non-staining on rubber mouldings or trims. Silicone free



| | | |
|--------------------|-------|--------|
| Part number: 85754 | 362ml | Bottle |
|--------------------|-------|--------|

DS SPONGES

Developed for manual sanding and matting of edges and contours of panels, not normally possible by machine sanding. Easy to use on profiled surfaces without risk of peeling edges, they create an excellent substrate refinish.

- ✓ 3 versions available - choice for each fine sanding job
- ✓ Extra long life and 2 sanding sides - saves money
- ✓ Will not clog or gum - reduces wastage
- ✓ Do not mark - ensures good finish for next working step
- ✓ Flexible - follows substrate irregularities / body contours
- ✓ Versatile - can be used wet or dry

| | |
|------------------------------------|-------|
| 30 PC; Fine P320/500 Brown | A1467 |
| 30 PC; Superfine P600/1000 Green | A1468 |
| 30 PC; Microfine P1000/1500 Purple | A1469 |
| 30 PC; Mixed box - 10 of each | A1473 |



KENT's DS Sponges Application Guide.

Premium sponges which offer the optimal solution for manual sanding and matting of edges and contours not possible by machine sanding.

BENEFITS

- ✓ Work either dry or wet
- ✓ Easy to use due to their special structure
- ✓ Ensure an excellent substrate refinish for the next lacquer layer

Fine



Grit
P320/500
Aluminium Oxide



Applications

- Electrophoresis and old laquer layers
- Refinish sanding before primer filler spraying

Super Fine



Grit
P600/1000
Aluminium Oxide-SC



Applications

- Electrophoresis and old laquer layers
- Filler sanding before basecoat spraying

Micro Fine



Grit
P1000/1500
AO-Silicon Carbide



Applications

- Preparation of lacquered surfaces
- Clear-coat fading

Note: For any product, please refer to the technical data sheet for the instructions for use.

ADDITIVES



FUEL GUARD 2

A unique, powerful and effective cleaner for the care and maintenance of the fuel system and other engine components on petrol and diesel engines, providing lubrication and anti corrosion protection. Applicable as a continuous treatment and/or a one off “rapid” fuel injection and system clean-up.

KENT Fuel Guard 2 was developed primarily as a lubricating & cleaning product, the active ingredient has the ability to effectively remove carbon and ash deposits and disperse them through the system during combustion.

The formulated additives provide lubricity, anti corrosion, anti oxidant and anti wear benefits to ensure continued clean smooth running of the engine. An improved dispersion system removes water contamination from the fuel system to avoid corrosion and the growth of micro organisms. Used regularly, it will also prevent the build up of sludge and other contamination.

KENT Fuel Guard 2 is a dual fuel system cleaner for both petrol and diesel combustion engines and compatible with all common unleaded gasoline/petrol (up to and including E10), red/off road diesel and bio-diesel.

It removes residues (gums, resins and tars that are present in all fuels) from the internal components whilst the formulation also lubricates moving components. In addition, the additive is effective at reducing emission levels which was confirmed and certificated by the TÜV THÜRINGEN/Germany.

- ✓ For use in petrol and diesel engines - reduces inventory
- ✓ Lubricates fuel components - extends pump & injector life
- ✓ Contains anti oxidants - reduces build up of lacquers, tars and gums
- ✓ Disperses water into fuel - avoids corrosion, microbial/fungal contamination
- ✓ Safe on catalytic converters, DPFs and compatible with all HDI engines
- ✓ Ashless dispersant - will not scour or damage engine parts

Part number: 83970
Part number: 83975

250ml
5L

Bottle
Container



DPF CLEANER ULTRA

Aids regeneration of the Diesel Particulate Filter by reducing the soot “light off” temperature, incorporates KENT Fuel Guard 2 as a fuel system cleaner and for long-term protection.

- ✓ Use as a preventative treatment or as a cure at first sign of a problem
- ✓ Reduces soot “light off” temperature - aids DPF regeneration
- ✓ Combats ash deposits on intake valves - for clean, powerful combustion

Part number: 86669
Part number: 87075

250ml
5L

Bottle
Container



TURBO AND GPF CLEANER

Maintain the exhaust gas flow through the exhaust system.

- ✓ Aids in the removal of deposits in the turbine housing
- ✓ 80% reduction in NOx emissions
- ✓ Helps to reduce soot build up in Catalyst, GPF and EGR valves

Part number: 86681

250ml

Bottle



FAP / DPF CLEANER

The use of FAP/DPF Cleaner is recommended when the particulate filter is too saturated and impossible to regenerate with the engine running.

- ✓ Formulated to dissolve soot and tar deposits from the particulate filter
- ✓ Fast working - results in 40 minutes

Part number: 86018

1L

Can



DIESEL TURBO FAP CLEANER

Turbo FAP/DPF Cleaner cleans dirty particulate filters and eliminates combustion residue

- ✓ De-scales and cleans the turbo’s variable geometry without disassembly
- ✓ Facilitates regeneration of particulate filters
- ✓ Reduces fuel consumption - extends life of catalyst and particulate filters

Part number: 85956

1.5L

Can

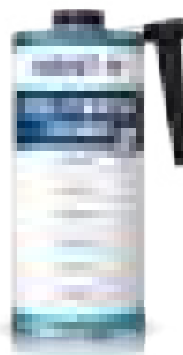

ENGINE STOP LEAK

An additive to revitalise old engine oil seals and prevent annoying oil leaks due to seal wear and ageing.

- ✓ Formulated to dissolve soot and tar deposits from the particulate filter
- ✓ No dismantling required - saves time and money
- ✓ Suitable for use in petrol and diesel engines

Part number: 86522

250ml

Bottle



GEARBOX STOP LEAK

An additive to revitalise old gearbox oil seals and to prevent annoying oil leaks due to seal wear and ageing.

- ✓ Effective on many seal/gasket materials, such as rubber, neoprene, EPDM, viton
- ✓ Contains gearbox oil anti-wear, detergent and dispersant additives
- ✓ Revitalises old gearbox oil seals - stops and prevents most oil leaks

Part number: 86523

250ml

Bottle



RADIATOR STOP LEAK UV

A cooling system additive to seal leaks, and indicate the damaged parts

- ✓ UV tracer shows where damaged parts are if holes are too big to be sealed
- ✓ Will continue to protect the system against new leaks – Preventative effect
- ✓ Seals small holes – Saves time and money compared to a radiator replacement

Part number: 86838

250ml

Bottle



OIL ENHANCER PLUS

Additive to boost the performance of all engine oils, particularly suitable for combustion engines fitted with Start/Stop systems

- ✓ Boosts depleted additives in the engine oil - restores engine oil performance
- ✓ Additives reduce premature wear on moving parts - increases component life
- ✓ Disperses carbon and sludge deposits - improves lubricant circulation

Part number: 86640

250ml

Bottle



RADIATOR OIL EMULSIFIER

An innovative blend of highly effective chemicals to enable the flushing of emulsified oil from the coolant system caused by head gasket, oil water cooler or other failure.

- ✓ Fast acting - Improves cooling system efficiency
- ✓ Contains powerful additives - Destroys all emulsified oils
- ✓ Cleans entire cooling system in one application - Reduces risk of overheating

Part number: 84666

250ml

Bottle



RADIATOR FLUSH

A blend of highly effective chemicals for the removal of oxidation and corrosion from within the cooling system.

- ✓ Suitable for use in all cooling systems - time saving
- ✓ Fast acting - improves cooling system efficiency
- ✓ Contains powerful additives - biodegradable in low concentrations

Part number: 84667

250ml

Bottle



ENGINE FLUSH

A blend of highly refined mineral oil, lubricating additives, dispersants, detergents, vegetable esters and emulsifiers. Designed to remove moisture, dirt and carbon deposits from an internal combustion engine.

- ✓ Absorbs water contamination in lubrication system - reduces risk of corrosion
- ✓ Contains effective sludge and carbon dispersant additives
- ✓ Special anti-wear additives - Protects engine components during cleaning

Part number: 86119

250ml

Bottle



DPF CLEANER FOAM

A powerful cleaning agent for diesel particulate filters that's easy to use.

- ✓ Cleans without disassembling the DPF - easy application, saves time / money
- ✓ Outstanding foaming action - penetrates deep into porous ceramic honeycomb
- ✓ Convenient aerosol application - economical use, only one can is required

Part number: 86547

500ml

Aerosol can



UREA ANTI CRYSTAL ADDITIVE

A concentrated additive to dissolve and prevent urea crystals formation. Cleans SCR (Selective Catalytic Reduction) system of diesel engines notably AdBlue® tank and injector.

- ✓ Dissolves crystals created by AdBlue® in vehicles SCR system at cold temps
- ✓ Concentrated formula – one 250ml bottle treats 100 litres of AdBlue®
- ✓ Optimizes Urea injector spraying – improves AdBlue® consumption

Part number: 86864

250ml

Bottle

Part number: 87003

2L

Container



PETROL ONE SHOT 2

A specific and effective short term rapid cleaner for petrol engines to compliment the long term fuel treatment of Fuel Guard 2.

- ✓ Effective cleaner for all parts of the fuel supply
- ✓ Improved carbon and ash removal and dispersion - cleans the injectors
- ✓ Ultra low aromatic hydrocarbon content - reduced NOx emissions

Part number: 84594

250ml

Bottle



DIESEL ONE SHOT 2

A specific and effective short term rapid cleaner for diesel engines to compliment the long term fuel treatment of Fuel Guard 2.

- ✓ Increased cetane value - improves cold starts reduces CO, HC, NOx emissions
- ✓ Low SAPS anti-wear and friction modifiers - lubricates fuel system components
- ✓ High flash point - not classified as flammable

Part number: 84595

250ml

Bottle





ADHESIVES

SUPER BOND

Our standard version for small and light applications.

- ✓ Our all-rounder suitable for smooth surfaces and most applications
- ✓ Improved formula - resistant to high temperature (120°C)
- ✓ Strong performance - high tensile and shear strengths

Part number: 86922

20g

Bottle



SUPER BOND GEL

Instant adhesive lets you bond even larger gaps, highly absorbent materials or vertical services quickly and cleanly.

- ✓ Reduced dripping – For application on vertical surfaces
- ✓ Strong performance – High tensile, shear strength and no blooming
- ✓ Improved formula - in a high quality bottle for a long shelf life

Part number: 86924

20g

Bottle



2K SUPER BOND

A gap filling instant adhesive/repair product with excellent adhesion to a broad range of materials and surfaces.

- ✓ High adhesion strength on many substrates - Long-lasting assembly
- ✓ Fills gaps up to 5 mm - Can also be used for bonding irregular surfaces
- ✓ Adhesive and activator in one - No need to add an activator as an additional step

Part number: 86663

10g

Syringe + 3 mixer nozzles

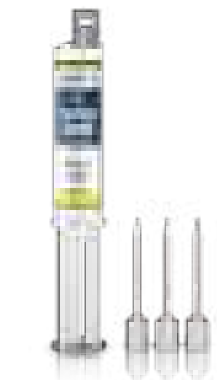

2K SUPER BOND FLEX

Flexible and elastic instant adhesive with high gap-filling properties

- ✓ Maximum flexibility - 200% elongation after full cure
- ✓ Impact/vibration absorbing - ideal for parts that flex or vibrate
- ✓ Adhesive and activator in one - no need for activator as additional step

Part number: 86921
86684

10g

Syringe = 3 mixer nozzles
Bag of 10 nozzles

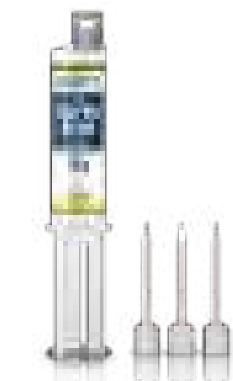

SUPER BOND ULTRA GEL

A non-sag rubber-toughened instant adhesive with excellent gap filling properties.

- ✓ Excellent impact strength – Resistant to shocks and vibrations
- ✓ Non-sag gel – Ideal for applications on vertical and overhead surfaces
- ✓ Gap filling – The best choice for filling small cracks and holes

Part number: 86516 20g Tube



SUPER BOND FLEX

Rubber enhanced cyanoacrylate adhesive, enabling repaired area to flex with the base material.

- ✓ Gap filling - the best choice for filling small cracks and holes
- ✓ Excellent impact strength - resistant to shocks and vibrations
- ✓ Non-sag gel - ideal for applications on vertical and overhead surfaces

Part number: 86517 20g Bottle



SUPER BOND PEN

A universal instant adhesive in a pen for strong high-precision repairs

- ✓ Instant adhesion - super fast in just 5 sec
- ✓ Precision pen - for high precision applications
- ✓ Strong performances - high tensile and shear strengths
- ✓ No blooming - for a perfect finish on visible repairs

Part number: 86923 6g Pen



SUPER BOND ACTIVSET

A fine mist spray for use with any Super Bond adhesive for increased bond strength and accelerated cure.

- ✓ Bonding strength achieved instantaneously
- ✓ Works on a variety of substrates including most plastics
- ✓ Improves bonding on difficult substrates

Part number: 86629 150ml Aerosol



SUPER BOND KIT

A selection of our best adhesives in a handy carry case.

Contains

- ✓ Super Bond - 20g (86922)
- ✓ Super Bond Gel - 20g (86923)
- ✓ Super Bond Ultra Gel - 20g (86516)
- ✓ Super Bond Flex - 20g (86517)
- ✓ Super Bond Pen - 6g (86924)
- ✓ Super Bond Activset - 150ml (86629)
- ✓ 2K Super Bond Flex - 10g (86921)

Part number: 86925

Case



HIGH BOND ONE SHOT

Structural adhesive for bonding glass to metal

- ✓ Fast - handling strength achieved after 5 minutes
- ✓ No clamping required - bonds in 15 to 30 seconds
- ✓ Strong - high resistance to impacts and vibrations
- ✓ Primer in a bottle with brush - no waste of product

Part number: 86901
86903

0.5ml adhesive + 0.5ml primer
0.5ml adhesive + 0.5ml primer - pack of 3



CLEAR BOND

A clear, non-drip contact adhesive for bonding most materials.

- ✓ Brush in lid - Saves time, no mess
- ✓ Bonds to wet and dry surfaces - Saves time in drying out surfaces
- ✓ Can be re-positioned - Easy to use

Part number: 34580

250ml

Tin



ROTABOND 2000

A high-performance single component MS polymer based and permanently elastic adhesive and sealer for metal, stone, wood, glass, rubber, ceramics and more.

KENT Rotabond 2000 features superior bonding properties. It bonds well to painted and blank metals, galvanised surfaces, copper, aluminium as well as wood, natural stone and most plastics without re-greasing. It bonds glass, mirrors, fibreglass and ceramics but also rubber, Styrofoam and even concrete and brick!

Its water compatibility and UV-resistance make Rotabond 2000 an ideal sealant for exterior applications. It ensures elastic sealing in any application area and is especially gentle on the material, does not require any protective equipment when handled and may even be used in areas in the proximity to foodstuffs.

- ✓ No solvents - can be over painted after skin forming
- ✓ Heavy bodied sealer - no slump or sag
- ✓ Totally flexible - will not shrink, crack or harden
- ✓ Does not string - neat application, quality finish
- ✓ Wet and dry application - saves time
- ✓ No isocyanates - safe to use / spot weld through

| | |
|--------------------|-------------|
| Part number: 34452 | Black |
| Part number: 34453 | Brown |
| Part number: 34454 | White |
| Part number: 34456 | Grey |
| Part number: 85465 | Silver Grey |



ROTABOND MS

A SMP (Silyl Modified Polymer) suitable for making elastic constructive joints and elastic seals with both adhesive and sealant performance.

- ✓ Primerless application – Time saving
- ✓ Permanently elastic – Will not shrink, crack or harden
- ✓ Neutral, odourless and fast curing – Easy to use

| | | |
|----------------------------|-------|-----------|
| Part number: 85081 (White) | 290ml | Cartridge |
| Part number: 85082 (Grey) | 290ml | Cartridge |
| Part number: 85083 (Black) | 290ml | Cartridge |



ROTABOND SE

Premium MS-Polymer based adhesive and sealant for everyday use

- ✓ For everyday use - Can be used for bonding and sealing
- ✓ Weather-resistant - For indoor and outdoor applications
- ✓ No solvents - Can be overpainted after skin forming

| | | |
|----------------------------|-------|----------------------|
| Part number: 86648 (White) | 290ml | Box of 12 cartridges |
| 86649 (Grey) | 290ml | Box of 12 cartridges |
| 86650 (Black) | 290ml | Box of 12 cartridges |



ROTABOND FAST TACK

Extremely fast one-component MS-Polymer high tack adhesive

- ✓ Extremely fast initial grab - Holds heavy loads instantly
- ✓ Very good green strength - High initial grab
- ✓ Easy to apply with hand gun

| | | |
|----------------------------|-------|-----------|
| Part number: 86608 (White) | 290ml | Cartridge |
|----------------------------|-------|-----------|



ROTABOND HI TACK

A high performance MS Polymer adhesive and sealant with extremely high final strength

- ✓ High performance - Extremely high final strength
- ✓ Does not string - Neat application and quality finish
- ✓ Heavy bodied adhesive - No slump or sag

| | | |
|----------------------------|-------|-----------|
| Part number: 85608 (Black) | 290ml | Cartridge |
|----------------------------|-------|-----------|



SEMI-FLEXIBLE EPOXY ADHESIVE

A strong 2K epoxy adhesive providing undetectable semi-flexible repairs on most plastics. Can also be used as a finishing cream.

- ✓ Excellent adhesion on most plastics (PP/EPDM, ABS, XENOY, TPO, PUR, etc.)
- ✓ Remains flexible after curing
- ✓ No chemical reaction in the oven or after paint process

Part number: 86448

50mm

Cartridge

Part number: 86031 (Mixer Nozzles Short)

Pack of 12

Part number: 86659 (2K Dispenser Gun)



2K METAL EPOXY ADHESIVE

A two-component, modified epoxy adhesive with a shiny steel finish for strong repairs on many substrates.

- ✓ May be machined, drilled, tapped or sanded – For a wide range of applications
- ✓ Thixotropic – For vertical and overhead applications
- ✓ Excellent resistance to chemicals – For applications in harsh environments

Part number: 86490

50ml

Bottle

Part number: 86031 (Mixer Nozzles Short)

Pack of 12

Part number: 86659 (2k Dispenser Gun)

1 piece



2K EPOXY PANEL BOND

Two-component structural epoxy adhesive showing high chemical and heat resistance.

- ✓ Bonds steel, SMC, aluminium, composite materials + many other substrates
- ✓ Unique anti-corrosion formulation
- ✓ High energy absorption, very good crash performance – Thatcham approved

Part number: 86496

195ml

Cartridge

Part number: 87007

220ml

Dual Cartridge

Part number: 86511 (Mixer Nozzles)

Pack of 3



RAPID BOND - 50ml

A two component methacrylate adhesive in an easy to use, 2K standard cartridge and 50ml cartridge.

- ✓ Ideal for structural joining of metals, composites, plastics and ceramics
- ✓ Latest acrylic elastomer chemistry
- ✓ Excellent resistance to hydrocarbons, acids and salt solutions

| | | |
|----------------------------------------------------------------|------|----------------|
| Part number: 86850 | 50ml | Black (5 min) |
| Part number: 86791 | 50ml | White (7 min) |
| Part number: 86856 | 50ml | Clear (90 sec) |
| Part number: 86807 - V2 Mixer Nozzles for 86791 (pack of 12) | | |
| Part number: 86392 - Mixer Tips for 86850 / 86856 (pack of 6) | | |
| Part number: 86393 - Mixer Tips for 86850 / 86856 (pack of 50) | | |



RAPID BOND - 220ml

Fast, powerful, extra-strong and durable structural bonding.

- ✓ High impact strength
- ✓ Primerless bonding for most metals – saves working time and money
- ✓ Remains flexible and allows filling large bond gap

| | | |
|--------------------|-------|----------------|
| Part number: 86852 | 220ml | White (5 min) |
| Part number: 85853 | 220ml | Black (15 min) |
| Part number: 85854 | 220ml | White (15 min) |



CONTACT SPRAY ADHESIVE

Multipurpose spray adhesive with a fast aggressive tack and an extended bond time.

- ✓ High initial grab - no need to clamp trims
- ✓ Long open time - allows bonding larger panels
- ✓ Versatile adhesive - bonds a wide range of lightweight materials

| | | |
|--------------------|-------|---------|
| Part number: 86593 | 500ml | Aerosol |
|--------------------|-------|---------|



PIPE SEAL

A high viscosity anaerobic thixotropic gel paste containing PTFE which cures rapidly, sealing instantly to 10 bar

- ✓ Approved for use with potable water and gas – BSEN751-1 – WRC – AGA
- ✓ Temperature Range: -50°C to +150°C
- ✓ Fast cure to fixtures usually <15 minutes @ 20°C

| | | |
|--------------------|------|--------|
| Part number: 86543 | 50ml | Bottle |
|--------------------|------|--------|



POWERLOCK

Very high-strength retaining compound and threadlocker, with excellent gap-filling properties.

- ✓ Excellent gap-filling properties - up to 0.25 mm
- ✓ High temperature resistance - up to 180°C
- ✓ Primerless on active and passive metals - saves time

Part number: 86541 50ml Bottle



PRELOCK

Medium-strength wicking grade threadlocker, for locking pre-assembled metal threaded assemblies.

- ✓ Penetrates threads by capillary action - ideal for pre-assembled assemblies
- ✓ High temperature resistance - up to 180°C
- ✓ Increased oil tolerance - locks assemblies even when not completely clean

Part number: 86542 50ml Bottle



STUDLOCK

Permanent stud-locker, high strength adhesive for the locking of studs and other threaded parts that will not normally be dismantled.

- ✓ Oil Tolerant – Ensures excellent locking even when parts are not clean
- ✓ Resistant – Produces seal resistant to chemicals, lubricants and more
- ✓ Wide temperature range (-55°C to +150°C) – Use with confidence

Part number: 86540 50ml Bottle



NUTLOCK

A general purpose medium strength anaerobic adhesive, designed to ease assembly of nuts & bolts then cure to prevent vibration loosening.

- ✓ Fast acting – No drip, and cures quickly to a hard resin
- ✓ Removable – Disassemble with normal tools
- ✓ Easy to apply

Part number: 86539 50ml Bottle



ALL IN ONE

An anaerobic sealer/locker with advanced resin technology containing PTFE for locking, sealing, securing and gasket making.

- ✓ Curing speed between 10-30 minutes @ 20°C
- ✓ Will only cured when deprived of oxygen
- ✓ Activator available for faster curing speeds and difficult substrates

Part number: 86544

50ml

Bottle



ANAEROBIC ACTIVATOR

Solvent-based activator for increasing the cure speed of anaerobic adhesives.

- ✓ Speeds up cure time - for faster return to service
- ✓ NSF K1 registered - for use in food-processing environment

Part number: 86545

200ml



MS STEEL HS

A SMP (Silyl Modified Polymer) based sealer that cures and leaves a glossy steel/aluminium finish.

- ✓ Shiny and bright silver finish - Good colour match for steel and aluminium
- ✓ Solvent; isocyanate and PVC free - Safe for user
- ✓ Very good UV resistance and ageing properties

Part number: 86066

290ml

Cartridge



MS CLEAR HS

A SMP (Silyl Modified Polymer) based sealer that cures and leaves a clear / transparent finish.

- ✓ Transparent after curing - Provides invisible seal
- ✓ No blistering while curing giving a smooth seal
- ✓ Conforms to DIN 52452 Section 4

Part number: 86865

290ml

Cartridge



PATCH N BOND STEEL

Hand-mixable, non-rusting, steel-reinforced epoxy putty that quickly repairs or rebuilds anything made of steel.

- ✓ Suitable for interior or exterior use - resistant to water, chemicals, temps
- ✓ Fast acting - cures in less than 10 minutes
- ✓ Easy to use - just cut what is needed and mix

Part number: 86694 114g Stick



PATCH N BOND AQUA

Hand-mixable epoxy putty that provides fast permanent repairs to damp, wet areas and underwater surfaces.

- ✓ Ideal for marine environment - can be applied underwater
- ✓ High chemical resistance to most industrial liquids
- ✓ Fast curing - functional strength achieved in 1 hour

Part number: 86695 114g Stick



PATCH N BOND ALU

Hand-mixable, non-rusting, aluminium epoxy putty, that provides fast permanent repairs to aluminium surfaces.

- ✓ Can be drilled, filed, tapped, milled and sanded in just 45 mins
- ✓ Putty like consistency eliminates drips/runs and ensures no mess
- ✓ Won't shrink or sag - use in many different applications

Part number: 86693 114g Stick



PATCH N BOND WOOD

Hand-mixable non-shrinking epoxy putty, which becomes an integral part of the wooden item being repaired, rebuilt or restored.

- ✓ Low density - ideal for repairs on wooden structures
- ✓ Ready to mix - no measuring or mixing tools necessary
- ✓ Fast curing - functional strength achieved in 1 hour

Part number: 86692 57g Stick



PATCH N BOND PLASTIC

Hand-mixable non-shrinking epoxy putty that provides fast permanent repairs to most rigid and semi-rigid plastics.

- ✓ Softest epoxy putty – ideal for repairs on semi-rigid and rigid plastics
- ✓ High chemical resistance to most industrial liquids
- ✓ Versatile – suitable for interior or exterior use

Part number: 86562 125g Stick



PATCH N BOND UNIVERSAL

Hand-mixable epoxy putty that provides fast permanent repairs to many materials.

- ✓ Universal – a must-have in every toolbox
- ✓ Ready to mix – no measuring or mixing tools necessary
- ✓ Fast curing – functional strength achieved in 1 hour

Part number: 86561 117g Stick



DECK BOND

A one component MS polymer adhesive sealant. It is especially designed for the bonding of teak and flexi-teak decks to iron, aluminum, fiberglass and other decking materials.

- ✓ Good ageing / UV resistance properties, long resistance against moisture
- ✓ Remains flexible at low/high temperatures – sound/vibration dampening
- ✓ Long open time and delivery in convenient bucket

Part number: 86985 5kg Tub



DECK CAULK

A one component MS polymer sealant especially designed for the watertight sealing of seams in teak decks and other decking materials.

- ✓ Very good UV resistance / ageing properties, resists fresh and salt water
- ✓ Solvent and Isocyanate free – No toxins, safe to use
- ✓ Can be sanded after curing – High quality finish every time

Part number: 86285 - black 600 ml Sausage
 Part number: 86451 - grey 600 ml Sausage



ADHESIVE TAPES



HIGH STRENGTH TAPE

A high peel strength double sided tape which can be used on most smooth hard surfaces including metals, plastics, painted and lacquered surfaces.

- ✓ Short term repositionable bond
- ✓ High bond, great alternative for mechanical fittings
- ✓ Superior adhesion to a wide variety of substrates
- ✓ Good low temperature flexibility
- ✓ Extreme weather and chemical resistance
- ✓ Leaves no residues when removed
- ✓ Absorbs shocks and vibrations

| | | |
|--------------------|------------|------|
| Part number: 34000 | 6mm x 15m | Roll |
| Part number: 34117 | 6mm x 7m | Roll |
| Part number: 34118 | 9mm x 15m | Roll |
| Part number: 34119 | 12mm x 7m | Roll |
| Part number: 40519 | 12mm x 15m | Roll |
| Part number: 34120 | 16mm x 7m | Roll |
| Part number: 40520 | 16mm x 15m | Roll |
| Part number: 34121 | 25mm x 7m | Roll |
| Part number: 40521 | 25mm x 15m | Roll |
| Part number: 86384 | 50mm x 15m | Roll |

Size Guide

6 mm

Part No: 34117 - 7 metre roll
34000 - 15 metre roll

9 mm

Part No: 34118 - 15 metre roll

12 mm

Part No: 34119 - 7 metre roll
40519 - 15 metre roll

16 mm

Part No: 34120 - 7 metre roll
40520 - 15 metre roll

25 mm

Part No: 34121 - 7 metre roll
40521 - 15 metre roll

50 mm

Part No: 86384 - 15 metre roll



HST CLEAR

A reinforced, high-tack clear acrylic double sided tape providing a superior bond to plastics and metals.

- ✓ Outstanding bonding properties - long lasting adhesion
- ✓ Virtually invisible after application - excellent for cosmetic fixtures and repairs
- ✓ Great conformability and stretching - ideal for special visual and design requirements
- ✓ UV and temperature resistant - excellent weathering properties
- ✓ Sound deadening - offers good acoustic insulation between glass wall partitions
- ✓ Easy-release liner - user friendly



Size Guide

6 mm

Part No: 86578 - 5 metre roll

12 mm

Part No: 86579 - 5 metre roll
86582 - 10 metre roll

19 mm

Part No: 86580 - 5 metre roll

25 mm

Part No: 86581 - 5 metre roll

TIGHTER BOND PRIMER

Adhesion enhancer for difficult surfaces. Recommended for use with High Strength Tape on surfaces with poor adhesion, eg. plastic bumpers

- ✓ Economical - Provides increased adhesion
- ✓ Easy to use
- ✓ Designed for use with all painted surfaces

Part number: 34586

250ml

Can



E-TAPE

Solid and spiral taping of wire harnesses in electrical and hybrid vehicles

- ✓ Protection of cables in electric and hybrid vehicles – high heat resistance
- ✓ Orange colour to guarantee the perfect OEM look – easy to identify for the user
- ✓ Solid – will not get loose during friction with other components

Part number: 86664

250ml

Can

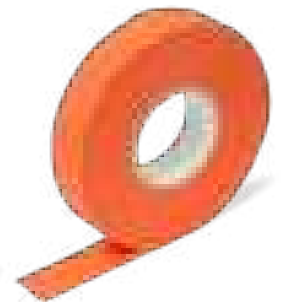

LOGO TAPE

Specially designed for recovering logos and emblems from all types of vehicles. It is also ideal for positioning parts before final fixing or for fixing decorative and promotional items.

- ✓ Badge reclaim
- ✓ Self cutting
- ✓ Easy to apply

Part number: 86687

100 mm x 200 mm

10 sheets (transparent)



BUTYL TAPE

For use in the replacement of older, direct glazed windshields and side windows.

- ✓ Bonds immediately on contact
- ✓ Will not sag or collapse
- ✓ Can also be used for sticking items of trim

| | | |
|--------------------|--------------|------|
| Part number: 20130 | 6.3mm x 4.5m | Roll |
| Part number: 20125 | 8mm x 4.5m | Roll |
| Part number: 20115 | 9.5mm x 4.5m | Roll |



VERSATAPE

Provides effective adhesion to most surfaces for the fixing of trim materials. Seals out moisture and remains pliable.

- ✓ Permanent plastic - no shrinkage
- ✓ Provides vibration and sound insulation
- ✓ Economical – saves time

| | | |
|--------------------|--------------|------|
| Part number: 34830 | 12.5mm x 15m | Roll |
| Part number: 34835 | 19mm x 15m | Roll |



FOAM BACKED DOOR SKIN ADHESIVE ROLL

An easy way to replace inner-door skin membranes. Comes in a single length which can be cut to size. The release liner grid is printed on to the paper to allow difficult shapes to be cut from it easily.

- ✓ Easy fit - Saves time
- ✓ Sound deadening - Reduces road noise
- ✓ Easy dispensing roll - Easy and convenient to use

| | | |
|--------------------|-------------|------|
| Part number: 84296 | 600mm x 10m | Roll |
|--------------------|-------------|------|



WATERPROOF TAPE

40% stronger than ordinary tapes. Will not fail in normal operation.

- ✓ Excellent tensile strength, tack and adhesion properties – Stays put
- ✓ Extra thick adhesive to provide excellent sealing - prevents water ingress
- ✓ Bonds to all types of surface – for many applications

| | | |
|-----------------------------------|------------|------|
| Part number: 84592 (Black) | 50mm x 50m | Roll |
| Part number: 86144 (Silver) | 50mm x 50m | Roll |
| Part number: 86905 (Blue) | 50mm x 50m | Roll |
| Part number: 86906 (Red) | 50mm x 50m | Roll |
| Part number: 86955 (Yellow/Black) | 50mm x 50m | Roll |

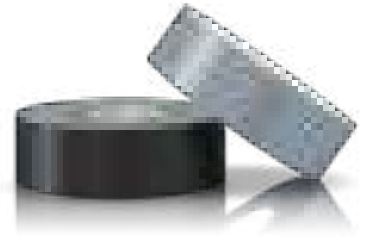

LINEN TAPE

Specially developed self-adhesive textile tape for original OEM wrapping of cables.

- ✓ Perfect for every type of cable bundling
- ✓ Easy to work with
- ✓ Good water resistance

| | | |
|--------------------|------------|------|
| Part number: 85776 | 19mm x 10m | Roll |
|--------------------|------------|------|



FUSION WRAP BLACK

A highly flexible self-vulcanising insulating wrap which gives excellent and permanent dielectric protection.

- ✓ Excellent temperature resistance – Use over a wide temperature range
- ✓ Self bonding, no adhesives required – Quick and easy to use
- ✓ Resistant to environmental exposure – Water / moisture / oil / chemicals

| | | |
|--------------------|--------------|------|
| Part number: 34725 | 25ml x 16.5m | Roll |
|--------------------|--------------|------|



PYTHON WRAP

A unique, easy-to-use, quick action system which when properly applied will repair broken parts damaged through everyday wear.

- ✓ Easy to use - Water activated, requires no mixing and is applied by hand
- ✓ Resistant to petrol, oil, acids, alkali and a wide range of other chemicals
- ✓ Can be sanded and painted - Initial cure within 30 minutes

| | | |
|--------------------|--------------|------|
| Part number: 30207 | 1.5m x 50mm | Roll |
| Part number: 30242 | 2.7m x 75mm | Roll |
| Part number: 30257 | 4.5m x 100mm | Roll |



PYTHON WRAP 2

Leak repairs made easy thanks to this extremely resistant self-vulcanizing silicone tape!

- ✓ No need to clean or sand prior to repair
- ✓ Extreme resistance to pressure, chemicals, UV and temperature
- ✓ Not harmful: not classified as carcinogenic, mutagenic and reprotoxic



Part number: 86067

1.5m x 25mm

Roll

EASY GRIP

No more drilling and hammering necessary! Signs and panels hold securely and solidly and can be easily replaced.

- ✓ Firm closure thanks to mushroom head elements
- ✓ UV-resistant and weatherproof
- ✓ Ideal for temporary fastening



Part number: 86446

25mm x 3m

Roll

EASY BIND

A high quality micro-snap fastener which provides a solid connection when pressed firmly together, product bonds to itself.

- ✓ Interlocking elements for fast re-closeable fastening – Can be repositioned
- ✓ UV resistant - Weather-proof
- ✓ Fast and easy to use



Part number: 85041

16mm x 10m

Roll

SPECIAL RELEASE AGENT

A specially formulated solvent which penetrates and softens most adhesives and butyl sealants allowing easy removal.

- ✓ Releases vehicle side mouldings, badges, glued-on trim and more
- ✓ Will not harm paint or rubber
- ✓ Eases cutting out of bonded glass

Part number: 30125

400ml

Aersol



ADHESIVE BACKED SHIM STOCK

A versatile, sponge rubber weather strip material. It is used to shim or fill openings between automotive parts.

- ✓ Easy to apply - Cut to length, remove backing paper and apply pressure
- ✓ Conformable, flexible – Will attach / seal to many difficult parts and surfaces
- ✓ Closed cell structure – Resists water, compression set, resists oil and fuel

| | | |
|--------------------|---------------|----------|
| Part number: 40100 | 16 x 3mm | 15m roll |
| Part number: 40125 | 12.5 x 8mm | 9m roll |
| Part number: 40130 | 12.5 x 14.3mm | 9m roll |
| Part number: 46475 | 32 x 3mm | 15m roll |
| Part number: 46480 | 6.3 x 4mm | 9m roll |
| Part number: 46490 | 9.5 x 8mm | 9m roll |
| Part number: 46495 | 9.5 x 11mm | 9m roll |
| Part number: 46505 | 19 x 11mm | 9m roll |
| Part number: 46510 | 25.4 x 8mm | 9m roll |
| Part number: 46515 | 25.4 x 14.3mm | 9m roll |



DOUBLE SIDED CLOTH TAPE

A hand-tearable double sided cloth tape combining very high initial grab and repositionability for a very wide range of applications.

- ✓ Easily tearable by hand
- ✓ Bonds to smooth and rough substrates
- ✓ Also suitable for low surface tension materials (PE, PP, PVC, TPO, etc.)

| | | |
|--------------------|------------|------|
| Part number: 86385 | 50mm x 25m | Roll |
|--------------------|------------|------|



MULTI SEAL TAPE

An excellent alternative to liquid sealants. Instant leak sealing of roof seams, rain gutters, flashing and vents, metal enclosures, skylights.

- ✓ Ideal for irregular surfaces, contours, edges, rivets and screw heads
- ✓ Excellent resistance to weather, abrasion, solvents, cleaning and more
- ✓ Stays flexible to compensate for vibration and thermal expansion/contraction

| | | |
|--------------------|-----------|------|
| Part number: 86386 | 38mm x 5m | Roll |
|--------------------|-----------|------|



XTREME FORCE TAPE

Reinforced double-sided tape with strong and immediate bonding on smooth and rough surfaces.

- ✓ 100% adhesion - bonds to pretty much anything, inc PP & PE plastics
- ✓ Reinforcement mesh inside the tape – extremely high strength
- ✓ No need to clamp or hold the bonded element – tape will not tear or get loose

Part number: 86665

19mm x 10m

Roll

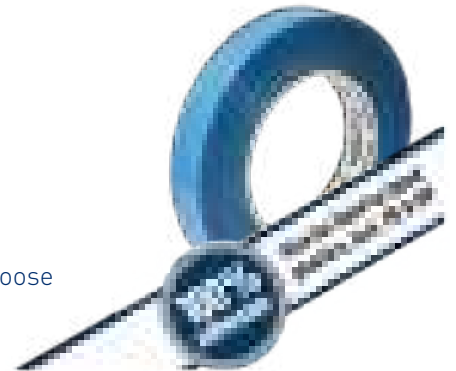

MULTI-TAPE EVO

UV resistant 100% residue-less duct tape for permanent outdoor use

- ✓ ZERO adhesive residue - perfect for outdoor applications
- ✓ Tearable by hand – easy to apply
- ✓ Scratch and abrasion resistant - ideal for masking where sanding is required

Part number: 86680

50mm x 50m

Roll

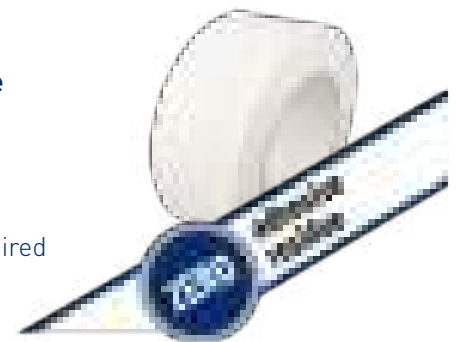

ANTI-SLIP TAPE

Very thin mineral-coated tape with high adhesion for anti-slip protection on smooth and slippery surfaces.

- ✓ Very thin - Low profile reduces trip hazards
- ✓ Overpaintable - Will not lose its rubbing properties
- ✓ Water and UV-resistant - Can be used indoors and outdoors

Part number: 86880

Black / Yellow

Roll

Part number: 86881

Black

Roll

Part number: 86882

Translucent

Roll



AIR CONDITIONING



UV LEAK DETECTION KIT

A complete, easy to use and solution for identifying leaks.

Contains:

- UV dye injection hose for R134a
- Universal A/C dye cartridges (service 20 vehicles)
- Cordless 'true' UV Phazer Light + Batteries
- Bleed valve to remove initial air from injection hose
- UV Enhancing Glasses

Features and benefits

- ✓ One kit for all types of leaks - air con, water, oil and fuel leaks
- ✓ True UV light - 3 x more powerful than blue light
- ✓ Cordless UV lamp with 100,000 hour LED
- ✓ Easy and safe to use - No training required

Part number: 85631

Kit



ACCESSORIES

A selection of products that complete the KENT A/C product range.

Part number: 84232 (UV Protection Goggles)

1 piece

Part number: 84234 (R-134a Low Side Injection Hose)

1 piece

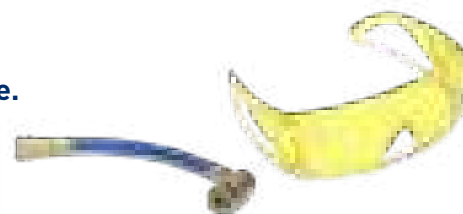

UV AIR CONDITIONING DYES

A high performance dye for use in conjunction with a UV lamp in identifying leak areas in air conditioning systems.

- ✓ Easy to use, inject cartridges directly into vehicle MAC system
- ✓ Reduces downtime and operation costs
- ✓ Removes guesswork

Part number: 85632

7.5ml

6 bottles

Part number: 84236

30ml

4 bottles

Part number: 85633

240ml

1 bottle



LEAK GUARD AND INJECTION KIT

Every brand new car leaks almost 3% of the refrigerant in the first year, The Leak Guard kit is a revolutionary solution to prevent and stop slow leaks that can occur over a 6-12 month period.

Contains:

- Injection gun
- Primer cartridge to pre-fill the injection hose
- 2 cartridges of Leak Guard
- Air-bleed adaptor
- High side R-134a adaptor hose



Features and benefits

- ✓ Stop slow leaks that can occur over a 6-12 month period up to 700g/year
- ✓ Compatible with all refrigerants
- ✓ Safely seals leaks of metal and rubber components in A/C systems
- ✓ Ideal for preventative maintenance

Part number: 86734

Part number: 85635 (cartridges)

30ml

Kit

Pack of 4

VENT AIR FRESHENERS

Leave vehicle smelling clean and fresh.

- ✓ Pack of 12 - Clip on vents
- ✓ Fragrance lasts for weeks
- ✓ Easy to use - Save time

Part number: 85630 (Spicy Apple)

Part number: 86013 (Summer Breeze)

Part number: 85979 (Vanilla)

Part number: 86643 (New Car)

Pack of 12

Pack of 12

Pack of 12

Pack of 12



SPOTGUNS A/C

A complete kit to allow user to keep oil and dye cartridges within easy reach and ready to use at anytime.

Contains:

- Wall mounted bracket
- 3 low side R-134a oil injection hoses
- 3 injection guns

Features and benefits

- ✓ Quick connect and easy to use
- ✓ Reduces downtime and operation costs



Part number: 85643

Kit

PAG OIL CARTRIDGES

Today's A/C systems require precise amounts of oil and specific viscosities. KENT PAG Oil cartridge system eliminates risk of oil contamination in the system.

- ✓ Meets OEM specifications
- ✓ Safe & cost effective - Eliminates risk of contamination
- ✓ Prevent oil overdose which can affect A/C system cooling performance

Part number: 85638 (100 viscosity)

240ml

Bottle

Part number: 85639 (46 viscosity)

240ml

Bottle



A/C STOP LEAK FOR R134A

Leak Stop without harmful polymers, will not harm or clog A/C system components or recovery machines

- ✓ Multi-purpose use – suitable for belt and electric driven compressors
- ✓ Stops leaks – effective on rubber, metal, gaskets and O-Rings
- ✓ Compatible with all oils – one product for PAG, POE and PAO

Part number: 86638

28.5ml



AIR CO ONE SHOT

A powerful high quality aerosol spray which disinfects, deodorises and refreshes the air conditioning system in vehicles. Effective against bacteria, fungi, yeasts and viruses.

- ✓ Viricidal action, **including coronavirus** - complies with EN14476
- ✓ Bactericidal – complies with the standard EN1276
- ✓ Fungicidal & yeasticidal – complies with the standard EN1650

Part number: 86436 100ml Aerosol



AIR CO REFRESH

A high performance product for use with all air conditioning units. The unique clinging foam action ensures fast, effective refreshing of all evaporator systems and ductwork.

- ✓ Low odour solvents - No residual smells
- ✓ Contains no ethyl-alcohol - Ensures the vehicle can be returned quickly
- ✓ 1m extension wand for use in long ductwork

Part number: 85788 (Forest Fruits) 300ml Aerosol
Part number: 86089 (Eucalyptus) 300ml Aerosol



BODY FILLERS



ULTRA FIBRE

A body filler with glass fibres designed for use on steel, aluminium and glass fibre reinforced plastic.

- ✓ Good adhesion to many surfaces – non sag formulation, apply thicker layers
- ✓ Easy to sand by hand/machine even with finer grits – does not clog the paper
- ✓ Can be over-painted with all leading primer/paint systems

Part number: 86959

1.8kg tin

Blue



ULTRA MULTI FIBRE

Gives you total confidence even when applying thick layers and offers a fine surface finish while increasing mechanical strength.

- ✓ Super light putty with glass fibres – increase strength of repaired element
- ✓ High dimensional stability - easy modelling of difficult shapes, no holes
- ✓ High substrate compatibility - steel, aluminium, galvanized, carbon and GFPR

Part number: 86940

1L tin

Yellow



ULTRA MULTI

The all-rounder for almost any filling work. Its easy handling, good filling properties make it the ideal companion for most jobs.

- ✓ Multifunctional use – can be used on various surfaces and vehicle types
- ✓ High thixotropy – very good shaping properties in any required thickness
- ✓ Good spreadability – larger and smaller areas can be worked on equally well

Part number: 86942

1.8kg tin

Beige

Part number: 86945

1.5kg cartridge

Beige



ULTRA FINISH

Combines easy working with fast drying, less effort to rub down and high surface quality

- ✓ Super smooth surface – ensures the highest surface quality of the repair area
- ✓ Replaces coarse sanding with fine sanding – shortens the repair process,
- ✓ Spot repair suitable – fill stone chips, scratches and other imperfections

Part number: 86943

1.8kg tin

White

Part number: 86946

1.5kg cartridge

White



ULTRA FLEX

A two-component polyester filler for filling small uneven spots and scratches on plastics.

- ✓ Can be very finely sanded to near non-existent film
- ✓ Soft and easy to sand – does not bounce or clog the paper
- ✓ Built-in sanding detector - changes colour during sanding, defects visible

Part number: 86957

1.8kg tin

Black



ULTRA ALU THX

Aluminium based filler that offers a fine finish, good forming properties and a high resistance to mechanical and temperature stress.

- ✓ Liquid metal appearance - greatly reduces the sanding effort
- ✓ Reinforces materials - ensures a stable paint build-up even on thin substrates
- ✓ Fast drying properties at 20°C - reduces energy consumption

Part number: 86961

1.8kg tin

Silver

Part number: 86962

1.5kg cartridge

Silver



NST RAPID SAND

A high quality styrene-free bodyfiller provides easy and smooth coating and hardens just as fast as other bodyfillers.

- ✓ 0% Styrene - more safety and comfort while applying
- ✓ Extraordinary drying properties - no time loss
- ✓ Suitable for all sheet metal surfaces - multifunctional applicable

Part number: 86744

1kg

Tin

Part number: 86989

1.5kg

Cartridge



HARDENER FOR BODY FILLERS

Spare hardener available to two sizes / form factors.

- ✓ Specifically designed for KENT's body filler range
- ✓ Choice convenience - choose between tube or cartridge

Part number: 86897

40g

Tube

Part number: 86898

40g

Cartridge



WALL DISPENSER FOR BODY FILLER 1.5KG

Wall dispenser for all cartridges of the ultra putty product range.

- ✓ Automatically dispenses the correct mix ratio of body filler / hardener
- ✓ Quick and easy to use

Part number: 86939

1 piece



MIXING PALLET

The new Body Filler Mixing Pallet provides a clean, contamination-free surface for mixing polyester filler pastes.

- ✓ 50 high quality, durable sheets
- ✓ Mounted on an ergonomically designed backing board

Part number: 83329

50 sheets

1 piece



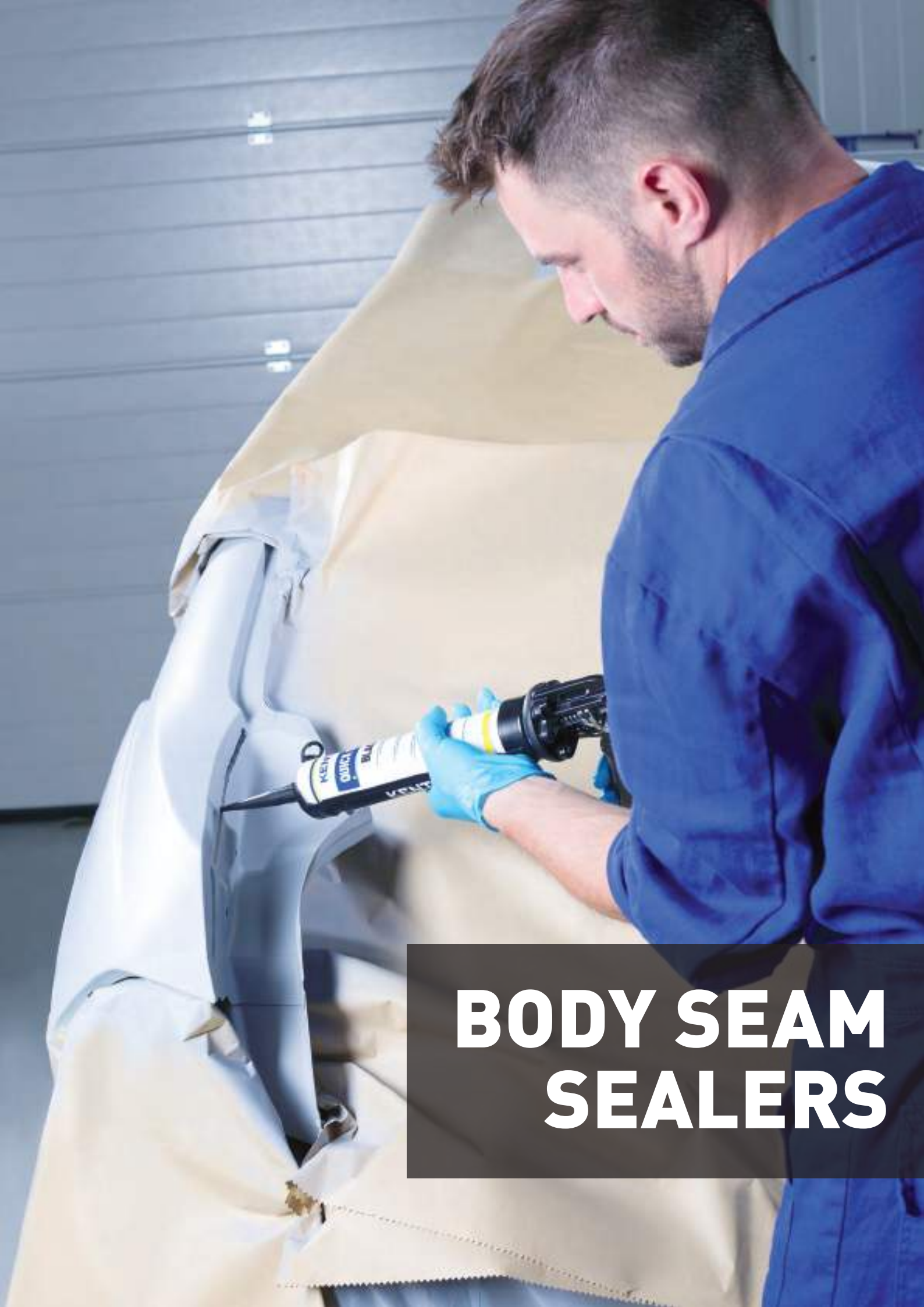

BODY SEAM SEALERS

QUICK SEAL

A premium quality vehicle body seam sealer formulated using the very latest chemical technology. It combines super adhesion with excellent sealant characteristics.

An environmentally friendly sealer and adhesive developed for body seam sealing. Quick Seal has very good UV resistance and ageing properties. Adheres to primed, painted and bare metal, zinc coating, aluminium, wood and most plastics without the use of a primer.

Automotive applications include sealing door skins, roof and bonnet struts, wings, boot floors, flitches, front and rear panels, suspension turrets and all butt and overlap joints. Quickseal can also be used for adhering Body Kits. Quick Seal will bond metal, glass, wood, most plastics, fiberglass, rubber, ceramics, concrete, brick and polystyrene to themselves and one another.

- ✓ No solvents - Can be over painted after skin forming
- ✓ No isocyanates - Completely safe to use & can be spot welded through
- ✓ Heavy bodied sealer - No slump or sag
- ✓ Totally flexible - Will not shrink, crack or harden
- ✓ Three sealers in one - Saves inventory
- ✓ Does not string - Neat application, quality finish
- ✓ Wet/dry application - Saves time

Part number: 34501 (White)
Part number: 34502 (Grey)
Part number: 34503 (Black)
Part number: 83405 (White)

290ml
290ml
290ml
600ml

Cartridge
Cartridge
Cartridge
Sausage



PROSEAL 404

Developed for body seam sealing, noise reduction coatings and OEM stone protection of sills, underbody and wheelhouses. Compatible with leading automotive paints.

Proseal has been developed to meet the needs of body shops to replicate the distinctive finish of the sprayed seam sealers used by OEM's in the manufacture of many vehicles.

Together with the Progun or Multigun, a variety of finishes can be obtained to match the diverse styles of Volkswagen, Citroen and many other vehicles.

Application areas include sills, boot and rear panel areas and around front suspension turrets. The black version is ideal for applications where overpainting is not required e.g. underbody and wheelhouses.

Proseal also doubles as a general sealer, albeit of a lower viscosity than Proseal 303, which makes it ideal for areas where a lower bead of sealer is required such as in certain door skin applications.

- ✓ Good spray ability - Easy to apply with little or no overspray
- ✓ Excellent finish structure - Replicates OEM finish
- ✓ Fast skinning/cure speed - Fast paint over & allows handling after short time
- ✓ Good paint adhesion with leading automotive paint technologies
- ✓ Excellent finish structure - Replicates OEM finish

| | | |
|----------------------------|-------|-----------|
| Part number: 86498 - Black | 290ml | Cartridge |
| Part number: 86499 - Grey | 290ml | Cartridge |
| Part number: 86917 - White | 290ml | Cartridge |



PROSEAL 303

A polymer based, one part, sprayable sealant, specially developed for the spray sealing of body seams to match OEM finish. It can also be used as an anti-chip coating or noise reduction layer on boot lids and bonnets.

- ✓ Medium viscosity - Can be used with other guns on the market
- ✓ Excellent finish structure - Replicates OEM finish
- ✓ Good spray ability - Easy to apply with little or no overspray
- ✓ Isocyanate free - No health hazards for user

| | | |
|----------------------------|-------|-----------|
| Part number: 85473 - Beige | 290ml | Cartridge |
| Part number: 85119 - Black | 290ml | Cartridge |
| Part number: 85616 - Grey | 290ml | Cartridge |
| Part number: 86916 - White | 290ml | Cartridge |



Optimal tools for the application of Proseal

Option 1



MULTI GUN

For extrusion and spraying of polymers and for the re-creation of various finishes in line with OEM appearances

Part No. 84325

Gives Proseal 303 and Proseal 404 a wavy structure



Use the KENT Multi Gun Nozzles (Part No. 84788) to extrude round or rectangular beads, that can be brushed afterwards. Without the nozzles, spray Proseal using the KENT Multi Gun.

Option 2



AIR PISTON GUN & AIR OPERATED GUN

Lightweight aluminium air caulking guns

Part No. 85669
Part No. 34894

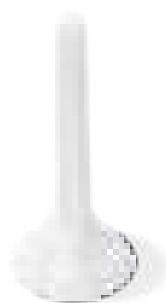

RIBBED SEAM NOZZLE

Special nozzle for achieving the OEM-like ribbed seam, e.g. on the door edges

Part No. 86667



Gives Proseal 303 a ribbed special structure



Best results were obtained by using KENT Air Piston Gun at ~4 bar or KENT Air Operated Gun up to 6 bar

FEATHERING BRUSH

A solvent resistant long bristle brush for feathering body seam sealers.

- ✓ High quality, long lasting and durable brush
- ✓ Solvent resistant
- ✓ Long bristles for easy, smooth application

Part number: 70524

1 piece



BUTYL HT

Ideal for sealing joints, back-filling as well as installation work and glazing.

- ✓ Good adhesion on different substrates without pre-treatment
- ✓ Product can be painted over
- ✓ UV and ageing-resistant

Part number: 84582 (Black)

310ml

Cartridge



SEALER ON A ROLL

A self-adhesive MS Polymer based sealing tape designed to quickly and effectively recreate the OEM finish on doors, bonnets, boot lids and wheel arches. Also available in half-moon shape.

- ✓ Directly over paintable after application – long waiting time for extrudable seam sealants
- ✓ Saves time like no other product - while always achieving a perfect OEM finish
- ✓ Substantial increase in productivity - more jobs without adding additional staff
- ✓ Process safe – immediate touchable without damaging sealants
- ✓ Cleaner to work – no smearing, no contact with hazardous chemicals
- ✓ Flexible tape - also applicable around corners

Part number: 83680 (Kit)

Includes 83681, 83682, 83683, 83679, 85304)

Part number: 83681 (Flat)

6mm x 16m

Roll

Part number: 83682 (Flat)

8mm x 16m

Roll

Part number: 83683 (Flat)

10mm x 16m

Roll

Part number: 86710 (Flat)

20mm x 5m

Roll

Part number: 86587 (Half-Moon)

3mm x 6.5m

Roll

Part number: 86588 (Half-Moon)

6mm x 9m

Roll

Part number: 86429 (Half-Moon)

8mm x 9m

Roll

Part number: 86430 (Half-Moon)

10mm x 9m

Roll

Part number: 86711 (Half-Moon)

12mm x 5m

Roll

Part number: 86712 (Wide)

12mm x 5m

Roll

Part number: 86713 (Wide)

15mm x 5m

Roll

Part number: 85304 (Primer)

400ml

Aerosol

Part number: 86714 (Roller)

1 piece



Body Seam Sealers

Part No. 86587

SEALER ON A ROLL

HALF MOON 3 mm x 6,5 m

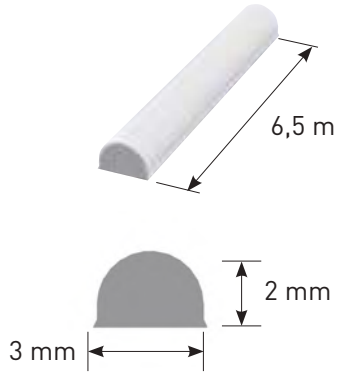

Part No. 86588

SEALER ON A ROLL

HALF MOON 6 mm x 9 m

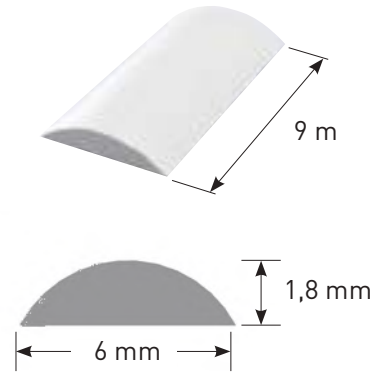

Part No. 86429

SEALER ON A ROLL

HALF MOON 8 mm x 9 m

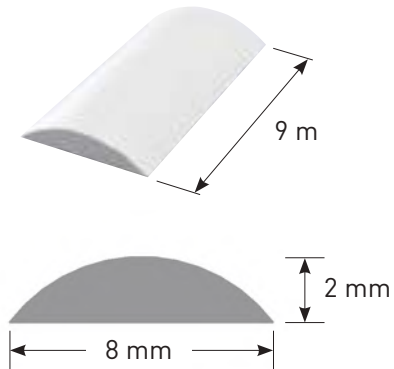

Part No. 86711

SEALER ON A ROLL

HALF MOON 12 mm x 5 m

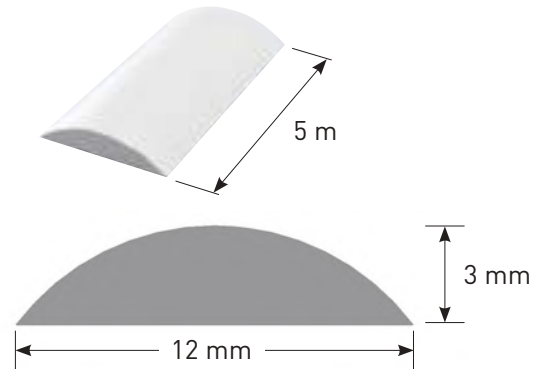

Part No. 86430

SEALER ON A ROLL

HALF MOON 10 mm x 9 m

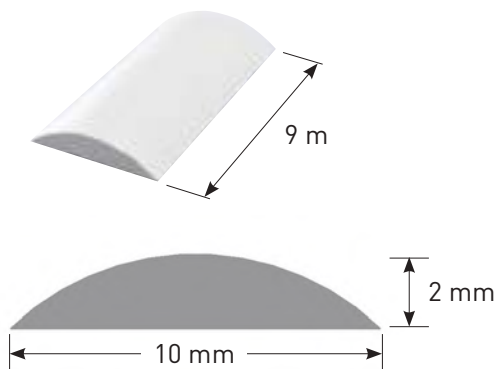

Body Seam Sealers

Part No. 83681

SEALER ON A ROLL

FLAT 6 mm x 16 m

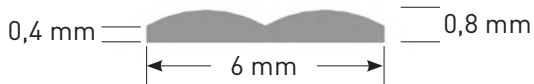
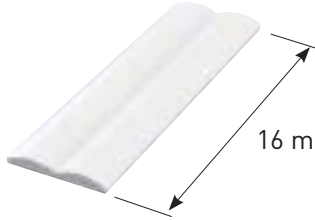

Part No. 83682

SEALER ON A ROLL

FLAT 8 mm x 16m

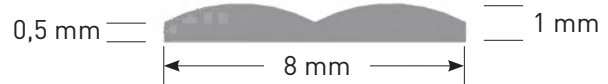
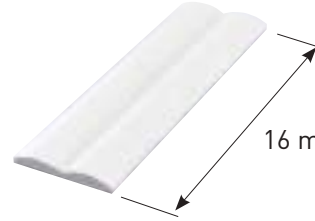

Part No. 83683

SEALER ON A ROLL

FLAT 10 mm x 16 m

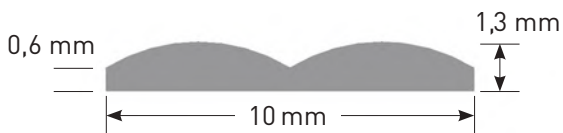

Part No. 86710

SEALER ON A ROLL

FLAT 20 mm x 5 m

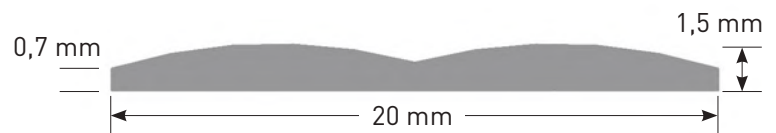
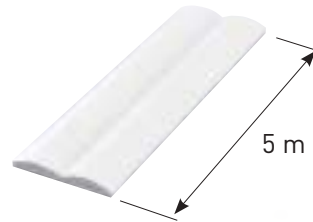

Part No. 86713

SEALER ON A ROLL

WIDE 15 mm x 5 m

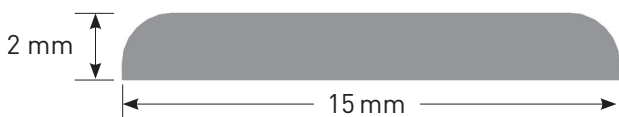

Part No. 86712

SEALER ON A ROLL

WIDE 12 mm x 5 m



BRAKE SERVICING



BRAKE PARTS CLEANER 2

Powerful, premium quality, fast drying cleaner.

- ✓ High-pressure spray blasts dirt and dust away
- ✓ Does not contain any carbon tetrachloride - safe for use
- ✓ Fast cleaning and drying - work faster

Part number: 86910 600ml Aerosol
Part number: 86920 750ml Aerosol



UNIVERSAL PARTS CLEANER

A high quality solvent for cleaning a variety of surfaces.

- ✓ Pure refined solvent - Leaves no oily film, odours or residues
- ✓ 360 degrees valve action - Sprays & cleans at any angle
- ✓ Very fast drying - Time saving

Part number: 84026 750ml Aerosol



BRAKE PLATE COPPER LUBRICANT

A high performance copper complex assembly or disassembly grease.

- ✓ High temperature range, good adhesion properties – will not melt or run out
- ✓ Provides long term lubrication with anti-wear properties
- ✓ Brush actuator provides optimal and economical instant application

Part number: 86559 200g Pressurised container



K44 SILICONE GREASE

Silicone oil based, moisture protecting lubricant.

- ✓ Wide temperature range -40°C to +200°C
- ✓ Good di-electric strength – Prevents arcing on electrics
- ✓ Good thermal conductivity – Use in temperature sensitive applications

Part number: 86005 80ml Tube



CERAMIC 1200

A high temperature ceramic based grease containing boron nitride particles for added temperature resistance. Ceramic 1200 is ideal for greasing nuts and bolts during disassembly. It has very good resistance to water and acids giving protection against rust / corrosion.

Suitable for use where copper based greases would normally be used i.e. where there is a considerable amount of heat generated and / or water present. Application areas are on braking systems, on the rear face of brake pads and moving edges of brake shoes. It is used to prevent items seizing or rusting together, particularly where they are regularly dismantled for service reasons i.e. where alloy wheels seat onto steel hubs.

It can also be used as a disassembly grease when threads are damaged. Ceramic 1200 is also used for either freeing off or assembling studs/nuts in areas where very hot temperatures are encountered such as exhaust systems. Finally, Ceramic 1200 is ideal for preventing ABS sensors corroding into their housings.

- ✓ Heavy metal free - Safe to use
- ✓ Very high temperature range -40°C to +1200°C - Wide variety of applications
- ✓ Specified for ABS braking systems - No 'come-backs'
- ✓ Assembly or disassembly grease – easy to use, saves time
- ✓ Contains anti corrosion inhibitor –improves corrosion resistance

| | | |
|---------------------------------------------------------|-------|---------------|
| Part number: 85235 | 400ml | Aerosol |
| Part number: 84298 (Bulk) | 200ml | Tub |
| Part number: 84335 (Pressure Pk) | 200ml | Pressure Pack |
| Part number: 84346 (Brush Applicator for Pressure Pack) | | 1 piece |



ANTI-SEIZE

High-grade temperature-resistant copper grease.

- ✓ Withstands extremes of temperature between -40°C and +1100°C
- ✓ Does not readily wash off – Lengthens part/vehicle life
- ✓ Will not be affected by acids, alkaline or salts

| | | |
|--------------------|-------|---------|
| Part number: 83972 | 500ml | Aerosol |
|--------------------|-------|---------|



CLEANING AGENTS



KENTO
**NEW ALL-PURPOSE
FOAM CLEANER**

A thick, persistent
foam cleans all soft and hard
trim plus all vinyl surfaces.

Detergent for use on all
surfaces. Safe for all.

Mehrzweckschäumreiniger für
alle Kunststoff-, Holz- und
Metzflächen.

Es ist ein universales, vielseitiges
Reinigungsmittel für alle
Innenflächen.

NEW AUTO CLAY

Revolutionary cleaning putty for universal use. A unique composition, this exclusive product removes all deposits and soiling.

- ✓ For glass, varnish, chrome and plastic surfaces
- ✓ Environmentally friendly composition
- ✓ Highly efficient polishing agent

Part number: 86590 200g 1 pc



PANEL DEGREASER

High quality water-based degreaser, preps surfaces prior to painting.

- ✓ Low VOC content - More environmentally friendly
- ✓ Excellent degreasing properties - Time saving
- ✓ Non aggressive: does not contain chlorates - Safe to use

Part number: 86213 1L Bottle
Part number: 86214 5L Container



ACRYSOL

A powerful solvent developed to clean and degrease surfaces by effectively removing deposits and remaining soiling such as oils, greases, waxes and adhesive residues.

- ✓ Pure 'virgin' solvent - Leaves no oily film or residues
- ✓ Very fast drying - No residual odours
- ✓ Non-aggressive, even for fresh paint

Part number: 83925 1L Can
Part number: 83930 500ml Aerosol

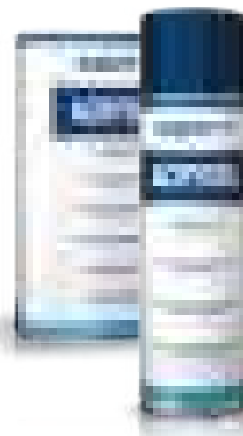

SPEEDY 500

An extra strength solvent which cuts through a wide variety of adhesives, cements and glues.

- ✓ Contains no chlorinated solvents or acetone
- ✓ Evaporates quickly without leaving any residue
- ✓ Multi-purpose - Can be used for removal of synthetic or resin based adhesive

Part number: 34705 1L Can



ELECTRIC CLEANER 2

A solvent based electrical cleaner which lifts and removes oxide films and removes dirt, dust & oil from electrical components and connections, whilst causing no damage to nylon or plastic components.

- ✓ Cleaner, Lubricant and Protector in one - Reduces inventory
- ✓ Lubricates as it cleans - Eases movement of electrical parts
- ✓ Leaves protective film - Prevents build up of oxidation and moisture

Part number: 34621 500ml Aerosol
Part number: 87076 (Easy Straw) 500ml Aerosol

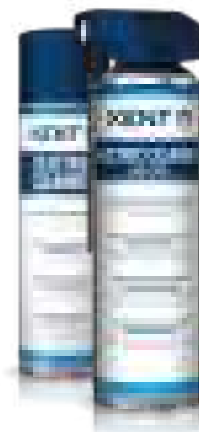

ONE SHOT 2

A very powerful and fast acting cleaner for the air induction side of fuel injection systems and carburettors.

- ✓ Fast drying - Leaves no oily film
- ✓ Safe on catalytic converters & oxygen sensors - No 'come-backs'
- ✓ Frees carburettor valves, linkages, thermostat coil, choke pistons/coils

Part number: 84835 500ml Aerosol



BRAKE PARTS CLEANER 2

Powerful, premium quality, fast drying cleaner for brakes etc

- ✓ High-pressure spray blasts dirt and dust away
- ✓ Does not contain any carbon tetrachloride - safe for use
- ✓ Fast cleaning and drying - work faster

Part number: 86910 600ml Aerosol
Part number: 86920 750ml Aerosol



SPECIAL RELEASE AGENT

A specially formulated solvent for penetrating and softening adhesives and butyl sealers prior to removal.

- ✓ Releases side mouldings and badges - Allows re-use and saves money
- ✓ Will not harm paint or rubber - Safe to use, no comebacks
- ✓ Softens Butyl adhesives - Eases cutting out of bonded glass

Part number: 30125 400ml Aerosol



CLEANER AND SPOTTER

A professional cleaner and spotter for removing grease and stubborn stains on dry cleanable fabrics and carpets.

- ✓ Lifts stubborn stains (oil, grease, tar)
- ✓ Quick drying - Saves time
- ✓ Trichloroethane free

Part number: 34691

500ml

Aerosol



PERFORMANCE NLR

Lifts dirt from soiled leather whilst the neutral pH and non-solvent base ensures that the cleaning action will not remove the protective oils, which are essential to keeping leather supple, soft and crack free.

- ✓ Water based - Safer in use on sensitive leather
- ✓ Silicone free - Body shop safe
- ✓ Easy to use - Saves time

Part number: 86877

1L

Bottle



PERFORMANCE NLC

A creme for light cleaning and replenishing the natural oils in leather as well as a cleaner and dressing for plastic components.

- ✓ Water Based - Safer in use on sensitive leathers
- ✓ Replenishes natural leather oils - Keeps leather supple
- ✓ Solvent free - Will not strip natural oils from leather

Part number: 83878

1L

Bottle



ALL PURPOSE FOAM CLEANER

A multi-use foam cleaner that can be used on both soft and hard surfaces. It is designed to overcome the use of many different imitator products with just one KENT product.

- ✓ Unique formulation - No streaking on glass
- ✓ Safe on most surfaces - One cleaner does all
- ✓ Quick drying - Saves time

Part number: 60071

750ml

Aerosol



NEW ALL PURPOSE FOAM CLEANER

A multi-use foam cleaner with a wide spectrum of applications. It can be used on soft and hard surfaces and is designed to quickly and easily produce a sparkling, smear free finish.

Specially formulated to overcome the use of many different competing products with just one KENT product. It can be used for all types of vehicles (inside and outside), industrial and MRO, handcraft, office including kitchen and washroom, windows and furniture.

On glass it is effective and quick, plastics are quickly returned to look as good as new and seats and headlinings can be cleaned without "soaking".
Fragranced so that it leaves a fresh, clean smell.

- ✓ Aerosol application – Quick drying action and economical use
- ✓ NSF-C1 listed – Suitable for food and beverage industry applications
- ✓ Does not contain D' Limonene – No skin sensitisation, safe on most surfaces
- ✓ Non-staining, leaves no residue – Streak-free clean, radiant shine on glass
- ✓ One cleaner for all applications – Less products on stock and in your toolbox
- ✓ Silicon free – Body Shop safe
- ✓ Flashes off quickly - Work fast
- ✓ Practical 750ml spray can - Convenient and easy to use

Part number: 84909

750ml

Aerosol



PERFECT INOX

An easy to use and extremely effective cleaner for stainless steel surfaces, with NSF approval, which leaves a protective coating to resist further tainting or marking.

- ✓ NSF (National Sanitary Foundation) approved - Safe for use in food areas
- ✓ Removes general dirt, residues, light grease - Effortless cleaning
- ✓ Protect surfaces against water / tainting marks - Retain quality finish longer

Part number: 84119

500ml

Aerosol



SOFT SURFACE CLEANER

A highly versatile, non-aggressive industrial solvent cleaner.

- ✓ NSF registered - Category K1, Registration 149836
- ✓ Exceptionally versatile, cleans and degreases - Reduced inventory
- ✓ Quickly evaporates - Leaves no film / residue - usable on most materials

Part number: 86485

500ml

Aerosol

Part number: 86785 (Easy Straw)

500ml

Aerosol

Part number: 85709

1L

Can



SOFT SURFACE CLEANER ZERO

A powerful non-aggressive solvent free cleaner which dissolves grease glue and dirt without leaving residues.

- ✓ Waterbased cleaner – No solvent and VOC contamination
- ✓ NSF A1 registered - Suitable for applications in food, beverage, pharmaceutical
- ✓ Cleans surfaces thoroughly – Removes grease, glue, resins and nicotine

Part number: 86799

500ml

Spray bottle



BLOW JET

A non-flammable air-duster for the safe removal of dust and debris from delicate or inaccessible areas.

- ✓ Pure, inert gas - Safe to use
- ✓ Chills to -50°C - Great for cooling components
- ✓ Moisture-free - Will not promote corrosion

Part number: 86938

400ml

Aerosol



SCREEN WASH 1:100

Concentrate with cleaning additives for the screen wash system.

- ✓ Highly concentrated – effective and intensive cleaning
- ✓ Pleasant fragrance – cleans and refreshes in one go
- ✓ Dosage head application on 250ml bottle – convenient and economical

Part number: 86937 250ml Bottle
Part number: 86935 40ml Bottle



MULTI CLEANER

A multi-purpose, water based cleaner for fabric, metal and head linings.

- ✓ Economical – Can be diluted 4 to 1 for lightly soiled surfaces
- ✓ Silicone free and not acid based - safe for use in paint/body shops
- ✓ Will not damage painted surfaces

Part number: 80260 1L Bottle
Part number: 80261 5L Container



MULTI-CLEANER GEL

A water-based, highly concentrated intensive cleaner for the removal of vegetable and mineral oils and greases, soot, paint residues and more.

- ✓ Highly concentrated – Effective and intensive cleaning
- ✓ Free of NTA and phosphates – Safe in use
- ✓ Silicone free – Body Shop safe

Part number: 86453 1L Bottle
Part number: 86476 (Spray Head) 1 piece



CITRUS CLEANER

Fast and effective intensive cleaning based on citrus extracts.

- ✓ High dissolving power – Effective and intensive cleaning
- ✓ Free from hydrocarbons and CFC content – Safe in use
- ✓ Silicone free – Body Shop safe

Part number: 86454 500ml Aerosol



WASH BAY CLEANER

A cleaning concentrate to remove stubborn dirt in wash bays and car wash facilities. It removes strong and sparingly soluble deposits such as chalk, brake dust, oil and grease residues and even rust stains.

- ✓ Highly concentrated – Economical in use
- ✓ Removes chalk – In a wash bay, dirt is mostly encapsulated in the chalk
- ✓ Silicone free – Body Shop safe

Part number: 86457 1L Bottle



TOILET CLEANER

Highly concentrated Toilet Cleaner Gel for fast removal of urine scale, chalk and other deposits.

- ✓ Good adhesion – Works on vertical surfaces
- ✓ Fresh fragrance – Cleans and refreshes in one go
- ✓ Highly concentrated – Economical in use

Part number: 86470 750ml Bottle



DRAIN CLEANER

Highly concentrated fast-acting liquid drain cleaner for the removal of hair and other organic deposits from siphons, pipes and drains. Without attacking seals and pipes.

- ✓ No dangerous fumes – Safe for the user
- ✓ Removes stubborn deposits – Keeps the workflow running
- ✓ Removes deep-seated blockage – Saves cost of a plumber

Part number: 86468 1L Bottle



GLASS KLEEN 2

A foam cleaner that quickly removes greasy film, insects and nicotine from glass and painted surfaces.

- ✓ Dissolves grease - Leaves a clean surface
- ✓ Unique formulation - No streaking or smearing on glass
- ✓ Quick Drying - Saves time

Part number: 85098 500ml Aerosol



AIR JET

A powerful air freshener which refreshes large areas in seconds.

- ✓ Refreshes in seconds – Quick and easy
- ✓ Can remain for several days – Long lasting
- ✓ Within one second you refresh a room up to 100 square metres

| | | |
|-----------------------------------|-------|---------|
| Part number: 86471 (Citrus) | 750ml | Aerosol |
| Part number: 86472 (Cranberry) | 750ml | Aerosol |
| Part number: 86473 (Cotton Fresh) | 750ml | Aerosol |



LIQUID ABSORBENT GRANULES

A quick and efficient absorber for aqueous liquids.

- ✓ Converts into gel – Easy to pick up and collected easily
- ✓ Absorbs up to 100 times its own weight – Economic in use
- ✓ Applicable on all kind of water-based liquids – Versatile

| | | |
|--------------------|------|-----|
| Part number: 86467 | 400g | Tub |
|--------------------|------|-----|



OIL ABSORBENT GRANULES

Absorbent granules for cleaning all liquid spills.

- ✓ High liquid absorbency – Uses less product, saves money
- ✓ Small granular size – Soaks up spill quickly, saves time
- ✓ 'Low dust' formulation, good 'skid' resistance – Easy clean up, less accidents

| | | |
|--------------------|-----|--------------|
| Part number: V2001 | 20L | Plastic sack |
|--------------------|-----|--------------|



SOLVENT RESISTANT PUMP SPRAYER

Features an adjustable nozzle for a long spray jet or fine atomiser.

- ✓ Resistant against many chemicals and solvents
- ✓ Visible filling level indicator
- ✓ Adjustable nozzle

| | | |
|--------------------|----|---------|
| Part number: 85737 | 1L | 1 piece |
|--------------------|----|---------|



ODOUR REMOVER

Neutralises odours and prevents formation of new odours.

- ✓ pH neutral odour remover – Does not damage surfaces
- ✓ Neutralizing agent – Removes unpleasant smells
- ✓ Non hazardous – Safe in use

Part number: 86464

500ml

Bottle

Part number: 86477 (Spray Head)

1 piece



POWER WIPES

Fast acting & reactivatable surface and tool cleaning wipes

- ✓ 90 wipes in one box giving you more applications than the standard boxes
- ✓ Can be reactivated with water when dried out – less waste of product
- ✓ Very high performance power wipes with one soft and one abrasive side

Part number: 86330

250ml

Bottle



FINISHING CLOTHS

Optimal for cleaning any surface and do not leave any scratch marks.

- ✓ High absorption power - Clean without streaks and lint
- ✓ Can be used dry, moist and wet - Very versatile

Part number: 86343 (Finishing)

40 x 40cm

Pack of 3



GLASS CLOTH

For streak-free cleaning of sensitive surfaces

- ✓ High absorption power
- ✓ Leaves no streaks or lints
- ✓ Can be used dry, moist or wet

Part number: 86755

1PC

Blue

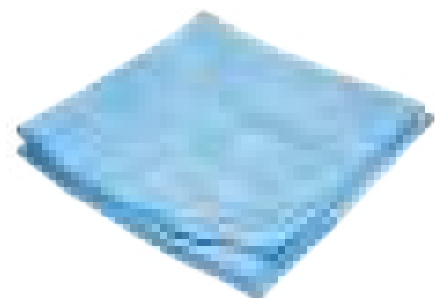

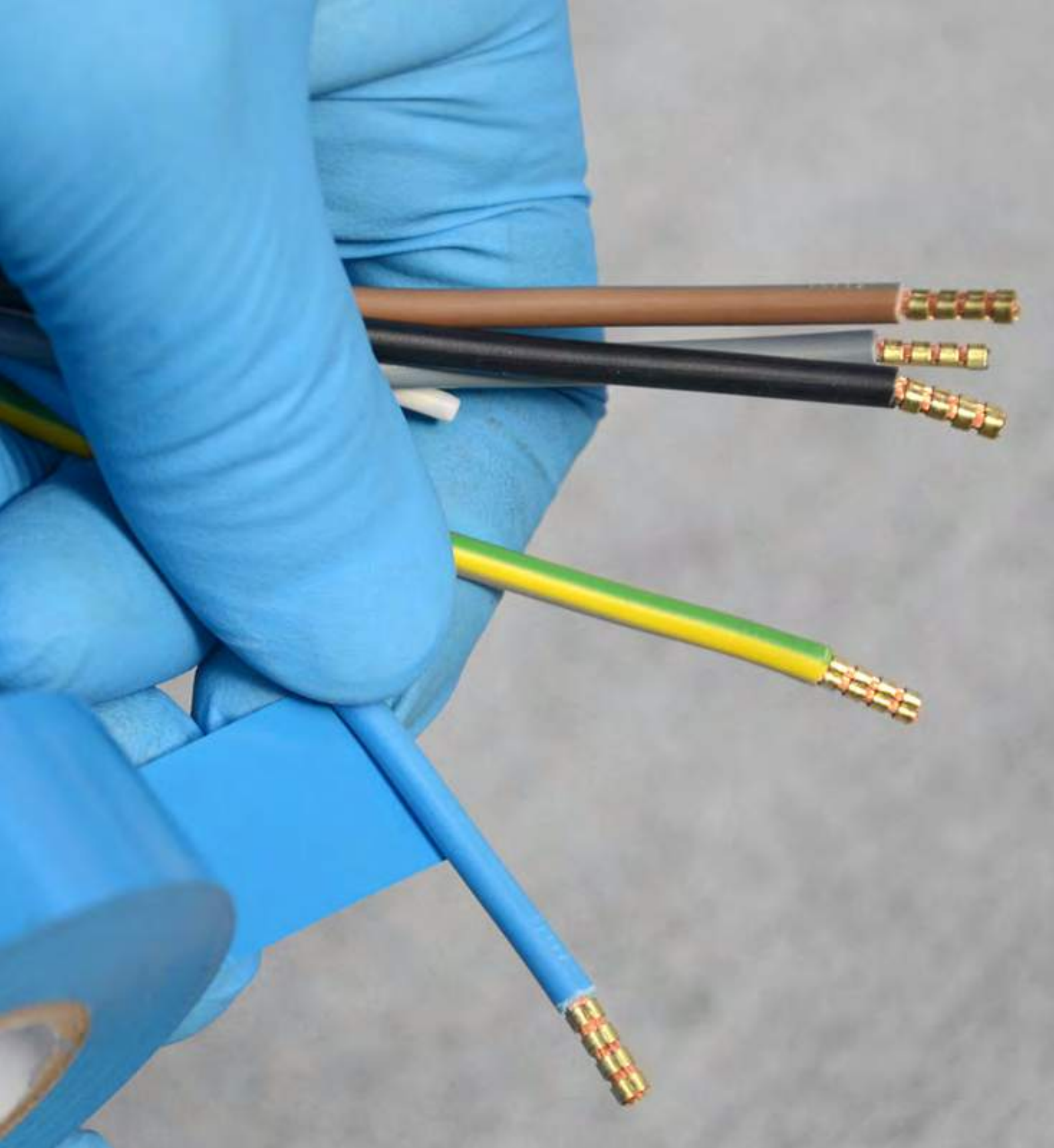

**ELECTRICAL
REPAIR**

CRIMP WIRE SPLICE

High performance, adhesive lined splice.

- ✓ Solders wire joints and seals in 1 - fast and secure joints
- ✓ Pre-fluxed, pre-formed solders - provides a controlled soldering process
- ✓ Transparent sleeve - allows inspection and gives insulation

Part number: 34061 (Red)

0.5 - 1.5 mm

Pack of 20



SOLDER SPLICE

A high performance splice with an internal ring of solder.

- ✓ Transparent sleeve - allows inspection and gives insulation
- ✓ Pre-fluxed, pre-formed solder - provides a controlled soldering process
- ✓ One-piece sleeve - enables easy installation and lowers cost

Part number: 34063 (Red)

0.5 - 1.5 mm

Pack of 20

Part number: 34064 (Blue)

1.5 - 2.5 mm

Pack of 20

Part number: 34059 (Yellow)

3 - 6 mm

Pack of 20

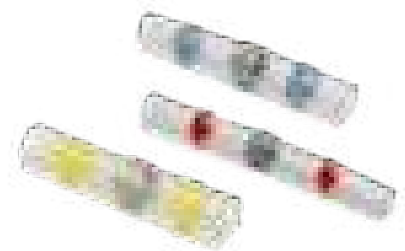

FLOWFORM CLEAR

High performance, clear, heat shrink tubing.

- ✓ Double wall design protects from corrosion, abrasion, breakage and pull out
- ✓ Melts easily to give exceptional moisture resistant connections
- ✓ Clear translucent colour allows visual examination of connections

Part number: 29925

3 x 300 mm

Pack of 10

Part number: 25290

6.5 x 300 mm

Pack of 10

Part number: 25295

10 x 300 mm

Pack of 10

Part number: 29935

13 x 300 mm

Pack of 10

Part number: 29940

20 x 300 mm

Pack of 5

Part number: 29945

25 x 300 mm

Pack of 5



CONDUCT ALOY SUPER SET

Low temperature solder with non-corrosive flux. No need for pre-cleaning; can be applied to dirty or highly oxidised copper.

- ✓ Low melting temperature - Can be melted with a cigarette lighter
- ✓ No waste - Instant setting with no drips or run off
- ✓ Repair leaks in air conditioning coils

Part number: 34016

1.5mm x 3m

Coil



QUICK FREEZE

A fast-acting cooling spray that has been developed to cool rapidly and then evaporate leaving no residue. It is ideal for testing temperature sensors and cooling other engine components.

- ✓ Controlled lowering of temperature - Use anytime, anywhere
- ✓ Clear gas - will not stain fabrics etc.
- ✓ Helps to ease in bearings / shafts in tight fittings - time saving

Part number: 86936

500ml

Aerosol



BATTERY TERMINAL GREASE

Protects metallic battery terminal contacts against moisture / corrosion.

- ✓ Resistant to ageing, oxidation, corrosion - Extends battery life
- ✓ Insoluble in water - Resists water wash-off
- ✓ Safe on most metals, plastics and rubber - Use with confidence

Part number: 86143

500ml

Aerosol

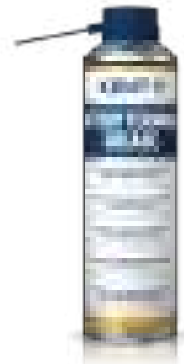

ELECTRIC CLEANER 2

A solvent based electrical cleaner which lifts and removes oxide films and removes dirt, dust & oil from electrical components and connections, whilst causing no damage to nylon or plastic components.

- ✓ Cleaner, Lubricant and Protector in one - reduced inventory
- ✓ Lubricates as it cleans - eases movement of electrical parts
- ✓ Leaves protective film - prevents further build up of oxidation

Part number: 34621

500ml

Aerosol

Part number: 87076 (Easy Straw)

500ml

Aerosol



ELECTRIC CLEANER NSF

A high performance, rapid dry cleaner for electrical applications. Non-toxic fast drying solvent leaving no residue to affect conductivity. Ideal for electrical equipment including contacts, motors and switches.

- ✓ Suitable for food/clean room environments
- ✓ Excellent cleaner/degreasing agent for electrical components. (DIN V 10517)
- ✓ Cuts through dirt, grease and grime - fast

Part number: 85310

400ml

Aerosol



SILICONE GREASE

A high quality 100% silicone grease for lubrication / moisture protection.

- ✓ High dielectric breakdown voltage - Prevents arcing on electrics
- ✓ Will not dry out or harden - Provides protection under adverse conditions
- ✓ Water resistant - Will not wash off

Part number: 34920
Part number: 86052

400ml
200ml

Aerosol
Pressure Pack



BLACK PVC INSULATION TAPE

Flame retardant and premium quality.

- ✓ Flexible with high elongation at break – Excellent conformability
- ✓ Easy to tear and unwind – User friendly
- ✓ Self extinguishing – Flame retardant to BS3924/EN60454

Part number: V1201

19 mm x 20 m

5 rolls



ASSORTED PVC INSULATION TAPE

An assorted pack of 10 premium quality, flame retardent rolls. Includes 3 black, 1 blue, 1 brown, 1 green, 1 red, 1 white, 1 yellow, 1 green/yellow

- ✓ Flexible with high elongation at break – Excellent conformability
- ✓ Easy to tear and unwind – User friendly
- ✓ Self extinguishing – Flame retardant to BS3924/EN60454

Part number: V1202

19 mm x 20 m

Pack of 10 rolls



FUSION WRAP

A highly flexible self-vulcanising insulating wrap, which gives excellent and permanent dielectric protection.

- ✓ Excellent temperature resistance - Use over a wide temperature range
- ✓ Self bonding, no adhesives required - Quick and easy to use
- ✓ Resistant to environmental exposure - Exceptional long term performance

Part number: 34725

25 mm x 16.5 m

Roll



GASKETING



SILI GASKET

An RTV gasket compound packaged in an easy to use and waste free pressurised container.

Many repairs and maintenance work on motor vehicle engines require sealing parts, surfaces or joints without pre-fabricated seals being available for this purpose. A universal engine sealing compound is especially suitable here; it neither affects sensors or the lambda sensor nor catalytic converters.

KENT Sili Gasket is a special engine sealing compound featuring these attributes and, thanks to the polysiloxane base, it vulcanises at room temperature. It thereby immediately seals in an oil and grease-resistant manner and allows fabricating one's own seals quickly and efficiently.

As an engine sealing compound, it is a fully equivalent substitute for a rubber seal or can reinforce an existing seal to ensure even better sealing. Thanks to vulcanisation the product is resistant against oils and greases immediately after application while frugally metered and reduces the cleaning effort. It bonds very well with rubber and is therefore also ideal for sleeves and bellows. It is ideal for sealing in water areas as well as back-filling material against rattling. Wherever you want to seal something in the engine area – you can make your own seal.

Features and benefits

- ✓ Pressurised container – No wastage
- ✓ Can be applied through grease & oil, easy dis-assembly – Saves time / money
- ✓ Conforms to GM 9985443 – Meets OEM requirements
- ✓ Sensor safe – Will not damage sensors or catalytic converters
- ✓ Can be applied to dress paper or cork pre-cut shapes – Easy to use

Part number: 86841
Part number: 87042

200ml
200ml

Push Valve
Lever Valve



SILI GASKET NEUTRAL

A neutral curing, non-acidic silicone sealant with the highest performance characteristics. An RTV gasket compound packaged in an easy to use and waste free pressure pack.

- ✓ Free of MEKO - contains no 2-butanone oxime and is less harmful to the user
- ✓ Weather resistant - unaffected by sunlight, UV, extreme temperatures etc
- ✓ High temperature resistance - up to 300° C

Part number: 86884 200ml Pressure pack



RAPID GASKET

An anaerobic compound specially developed for the sealing of close fitting gaskets and flange assemblies. It is an instant low-pressure sealant, forms any size or shape and will not shrink or relax.

- ✓ Excellent gap-filling properties - up to 0.30 mm
- ✓ Seals instantly against low pressure - up to 3 bar
- ✓ High temperature resistance - up to +180°C

Part number: 86553 50ml Concertina bottle



EXHAUST PASTE

A one part dual heat and air cure system based on a modified silicate cement. It is used when assembling exhaust component together to give leak free joints.

- ✓ Wide operating temp to -50 to 1500°C
- ✓ Good adhesion to metal, brick and concrete
- ✓ Skin Time: 5 minutes (20C/ 50%RH) - Fast re-assembly of components

Part number: 86736 150g Tube



SIL PACK

A specially formulated gasket making compound for all industrial applications.

- ✓ Can be applied through grease and oil - Saves time cleaning up
- ✓ Sensor safe - Will not damage sensors or catalytic converters
- ✓ Skins quickly - Reduces assembly time

Part number: 87044 (Lever Valve) 200ml Pressure Pack
Part number: 86843 (Push Valve) 200ml Pressure Pack





**HEALTH &
SAFETY**

DRY HAND CLEANER

Professional solvent-free and waterless hand cleaning foam

- ✓ Waterless use –Get clean hands onworking site
- ✓ Cleans heavy dirt - Doesn't leave hands greasy or dry
- ✓ Up to 90 doses per spray –less wastes than wipes

Part number: 86689 150ml Aerosol



PAINT HAND CLEANER 2

Intensive action hand cleaning paste for removing lacquers, paints, glues, resins and many other stubborn residues.

- ✓ Cleans deep into the pores – Removes stubborn dirt
- ✓ Skin-friendly, dermatologically tested – Ideal for frequent use
- ✓ Contains an organic abrasive – More environmentally friendly

Part number: 86504 250ml Tube



GENERAL HAND CLEANER

Cleanses deep into the pores, and is gentle on the skin.

- ✓ Highly concentrated – Only 3ml required for thorough cleaning
- ✓ Contains finely ground walnut shell meal as natural abrasive agents
- ✓ pH neutral and silicone free – Body Shop safe

Part number: 86598 3L Tub
Part number: 86683 2L Soft bottle for dispenser
Part number: 86202 (3L dispenser) 1 piece
Part number: 86203 (3L dispenser + wall bracket) 1 piece
Part number: 86205 (3 way dispenser) 1 piece



HAND CLEANING SOAP

Liquid hand cleaning soap for frequent use.

- ✓ pH neutral, dermatologically tested – Kind on sensitive skin
- ✓ Refattens using glycerine derivatives – Ideal for frequent use
- ✓ Silicone free – Body Shop safe

Part number: 86482 2L Soft bottle for dispenser
Part number: 86260 (Pump dispnser for 1L bottle) 1 piece
Part number: 86494 (Wall dispenser 2L) 1 piece



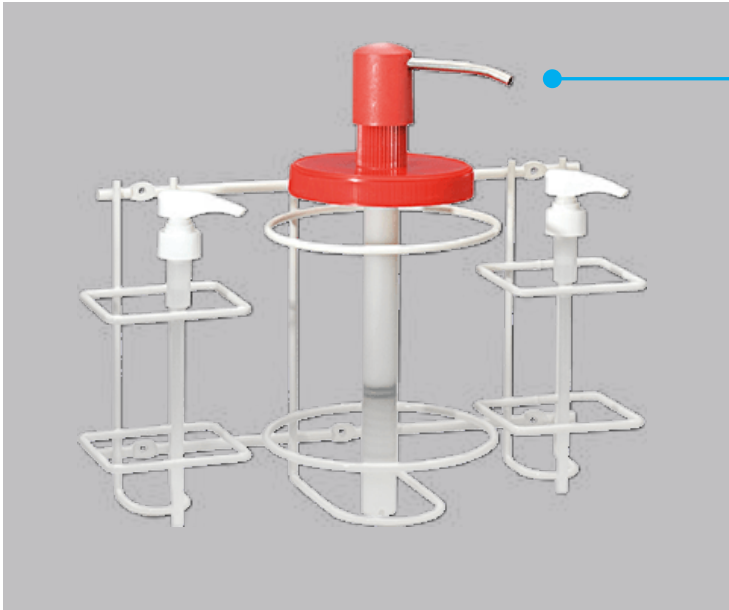

Three Pack Wall Mount + Pump Dispensers

Part No: 86205 00

For: General Hand Cleaner 3L
Skin Care Lotion 1L
Skin Barrier Lotion 1L

Includes: Wall Mounting Frame
Required fixings
1 x 3L Pump Dispenser
2 x 1L Pump Dispenser

Wall Mount + 3L Pump Dispenser

Part No: 86203 00

For: General Hand Cleaner 3L

Includes: Wall Mounting Frame
Required fixings
1 x 3L Pump Dispenser

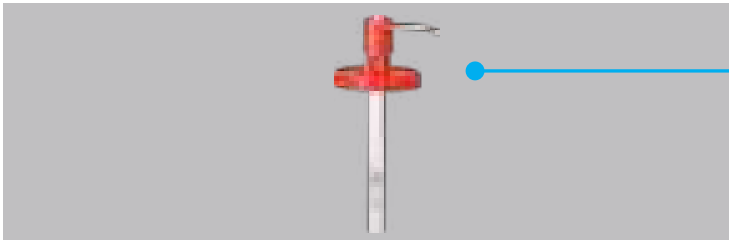
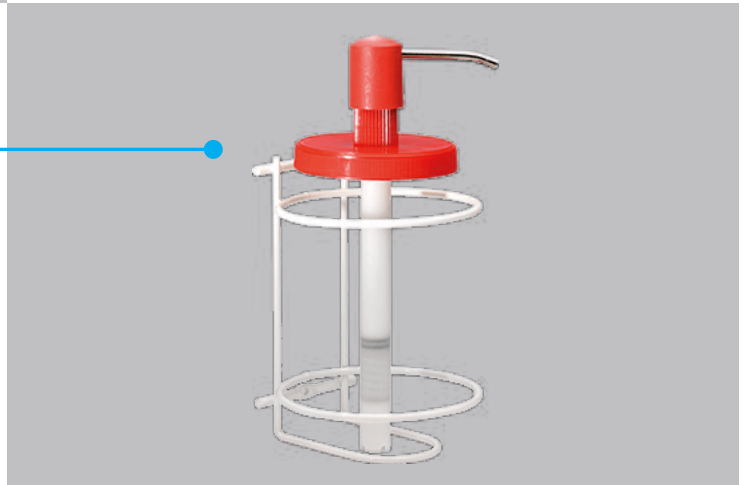

3L Pump Dispenser

Part No: 86202 00

1L Pump Dispenser

Part No: 86260 00



WALL DISPENSER FOR 2L SOFT BOTTLES

Designed for KENT 2L soft bottles (Hand Cleaning Soap and General Hand Cleaner). A sturdy plastic dispenser which ensures exact and economic dispensing. It can also be locked.

- ✓ Sturdy plastic dispenser
- ✓ Exact and economic dispensing
- ✓ Lockable

Part number: 86494 2L 1 piece



SKIN BARRIER LOTION

pH-neutral, silicone free, skin protecting cream.

- ✓ Protects the skin against aqueous and non-aqueous substances
- ✓ Top quality source of moisture, pH-neutral and free from silicone
- ✓ Use before handling risky substances

Part number: 86200 1L Bottle
Part number: 86205 (3 way dispenser) 1 piece



SKIN CARE LOTION

A high-grade skin care lotion for mild to intense skin stress.

- ✓ Rich in active ingredients
- ✓ Light fatty and easily dispersible
- ✓ pH neutral and silicone free

Part number: 86201 1L Bottle



HAND WIPES

All-in-one textured wipe uniquely designed to conveniently clean, dry and moisturise hands in one single operation.

- ✓ Textured wipe gently and effectively removes the most stubborn soils
- ✓ Optimum dose of hand cleaner applied – No saturation
- ✓ Antibacterial (BS EN 1276:1997)

Part number: 86088 Tub of 50 wipes



SAFETY GLASSES

A clear, lightweight, wrap-around eyeshield.

- ✓ Can be used on top of regular spectacles
- ✓ Vented sideshields
- ✓ Complies with EN166,1,F



Part number: V1225

One size

1 pc

THREE LAYER GLOVES

Premium one-time glove for maximum protection against chemicals including acids, solvents and alkalis.

- ✓ Thin wall construction, textured fingertips - higher tactile sensitivity and grip
- ✓ Powder free, silicone and latex free, anti-static - improved product protection
- ✓ Officially EN ISO 374 and KOSHA certified



Part number: 86677

Size. M

25 pairs

Part number: 86678

Size. L

25 pairs

Part number: 86679

Size. XL

25 pairs

MECHANICS GLOVES

A re-usable silicone-free nylon knitted glove with a nitrile coating to palm and fingers and without seams.

- ✓ Breathable nitrile coating - Improves grip and comfort
- ✓ Good abrasion, cut and tear and perforation Resistance - Protects hands
- ✓ Good sensitivity - for a good sense of touch



Part number: V2298

Small (S7)

12 pairs

Part number: V2234

Medium (S8)

12 pairs

Part number: V2235

Large (S9)

12 pairs

Part number: V2236

Extra Large (S10)

12 pairs

E-GLOVES

Gloves for the maintenance of electric and hybrid vehicles.

- ✓ Class 0 gloves suitable for a maximum working AC voltage of 1000V
- ✓ Certified resistance to acid, Ozone and very low temperatures
- ✓ Ideal for applications with a risk of touch voltage AC $\geq 50V$



Part number: V2274

Size. M

1 pair

Part number: V2275

Size. L

1 pair

Part number: V2276

Size. XL

1 pair

DISPOSABLE COMFORT MASK

Protecting masks for non-toxic and nuisance dusts. No CE marking. The masks do not provide protection against fine dusts, fibres, mists, metal fume gases, vapour or paint spray.

- ✓ Relief from coarse particles of non-toxic / nuisance dusts
- ✓ High level of comfort

Part number: V1226

One size

Pack of 50



DUST / MIST RESPIRATOR

Comfortable fine dust mask. EN149 – FFP2S approved.

- ✓ Relief from fine dust, fibres and aqueous mists and fibres
- ✓ Comfortable to wear

Part number: V1227

One size

Pack of 20



PROPAIN OVERALLS

A dust-tight (and to a limited degree) spray-tight overall which will protect the user against hazardous particles of dust and against splashes of aggressive chemical liquids.

- ✓ Type 5 + 6 (Particle tight-clothing + limited splash clothing)
- ✓ CE0121: Euro standard for personal protective clothing - category III
- ✓ Anti-statically treated protective clothing

Part number: V1900

Medium

1 piece

Part number: V1901

Large

1 piece

Part number: V1902

X-Large

1 piece



LUBRICANTS & PENETRANTS

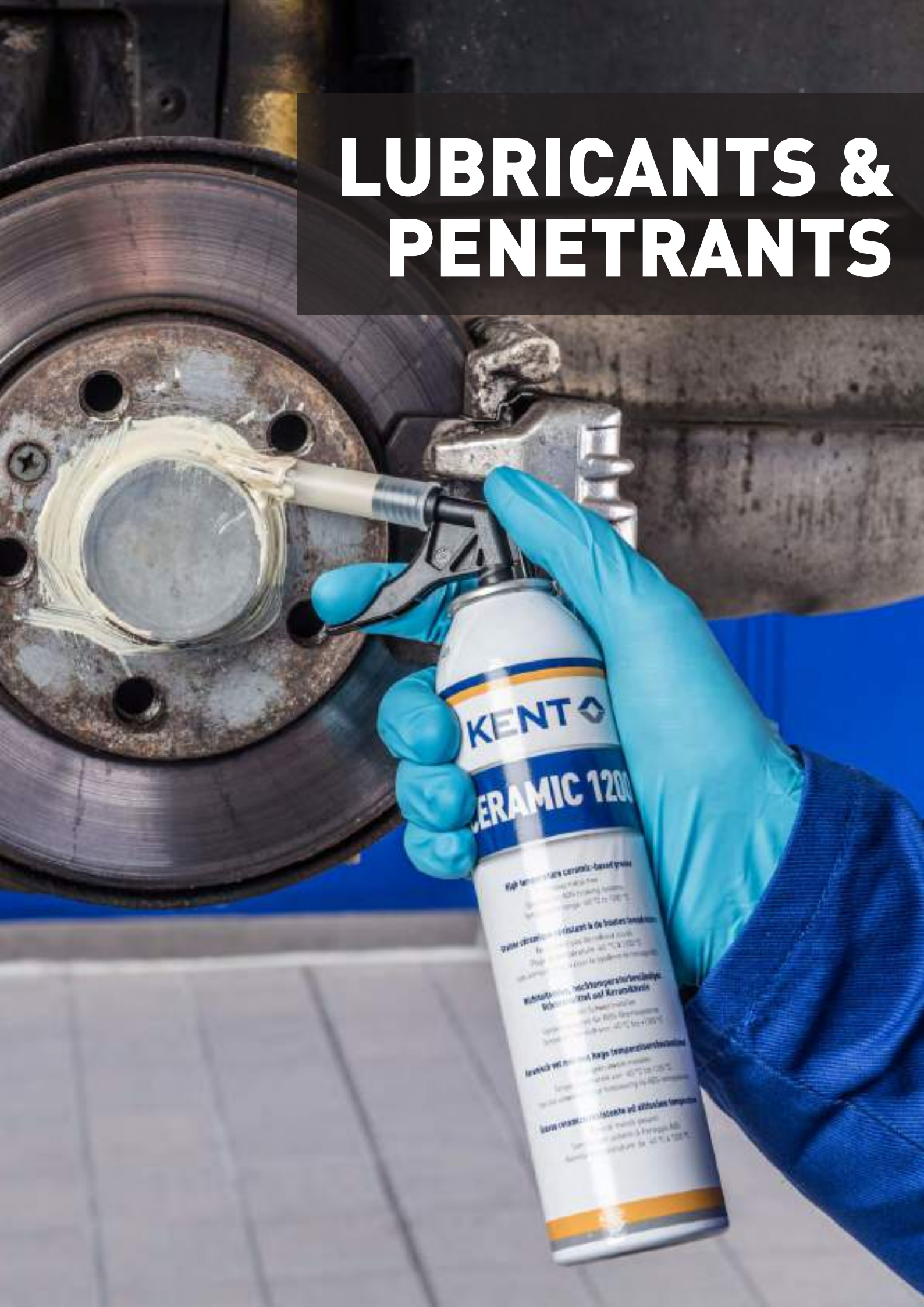

KENT

CERAMIC 1200

High temperature ceramic-based grease

Great chemical resistant to de-buster solvents

Multi-purpose, high-temperature lubricant

Lowest VCI content, high temperature resistance

Low content of volatile organic compounds

CERAMIC 1200

A high temperature ceramic based grease containing boron nitride particles for added temperature resistance. Ideal for greasing nuts and bolts during disassembly. It has very good resistance to water and acids giving protection against rust and corrosion.

Ceramic grease is extremely well suited for use where copper based greases would normally be used i.e where there is a considerable amount of heat generated and/or water present. Application areas are on braking systems, on the rear face of brake pads and on the moving edges of brake shoes.

It is also used to prevent items seizing or rusting together, particularly where they are regularly dismantled for service reasons i.e wheel stud threads and where alloy road wheels seat on to steel hubs.

Ceramic grease is also used for either freeing off, or assembling studs / nuts in areas where very hot temperatures are encountered such as exhaust systems. C1200 is ideal for preventing ABS sensors corroding into their housings.

Finally, it reduces the effect of caustic acids and chemicals and is resistant to fresh and salt water.

Features and benefits

- ✓ Heavy metal free - Safe to use
- ✓ Very high temperature range -40°C to +1200°C - Wide variety of applications
- ✓ Specified for ABS braking systems - No 'come-backs'
- ✓ Assembly or dis-assembly grease - Reduced inventory
- ✓ Grey Colour - Less obvious in visible locations i.e. wheel nuts
- ✓ Prevents oxidisation - Easy to dis-assemble, saves time

| | | |
|-----------------------------------------------------|-------|---------------|
| Part number: 85235 | 400ml | Aerosol |
| Part number: 84298 | 200g | Tub / Bulk |
| Part number: 84335 | 200ml | Pressure pack |
| Part number: 84346 (Pressure pack brush applicator) | | 1 piece |
| Part number: 70524 (Feathering brush) | | 1 piece |

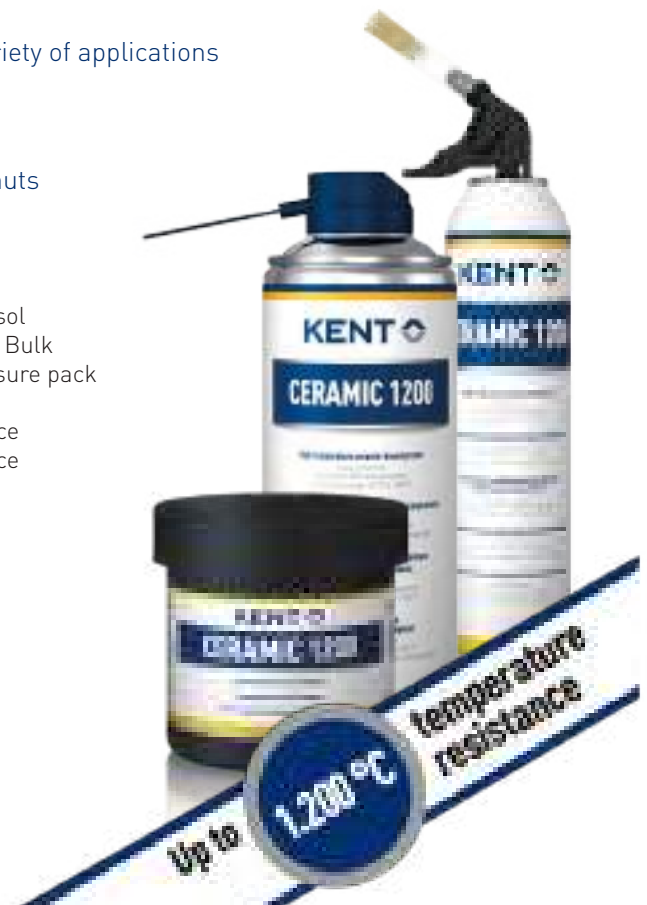

INJECTOR RELEASE AGENT

Enables non-destructive removal of seized injectors from diesel engines and effectively removes carbon deposits, oil residues, gumming etc.

- ✓ Slide-active PTFE-particles assist removal of the components
- ✓ Freezes down the material to -30 °C
- ✓ Fast acting - reduces amount of work and thus costs

Part number: 86313 500ml Aerosol



ANTI-SEIZE

A redemption and assembly paste containing very small copper particles in a non-melting Bentone base grease together with very strong anti-corrosion and anti-oxidation inhibitors.

- ✓ Withstands extremes of temperature between -40°C and +1100°C
- ✓ Does not readily wash off – Lengthens part / vehicle life
- ✓ Will not be affected by acids, alkaline or salts

Part number: 83972 500ml Aerosol



BLUE GREASE

A high performance, multi-purpose grease formulated with a highly refined mineral oil thickened with a lithium-complex soap and contains EP additives for anti-wear protection.

- ✓ Good pressure resistance - Reduces wear due to friction
- ✓ Good water-wash out resistance - Will not emulsify with water
- ✓ Resistant to corrosion and oxidation - Protects moving parts

| | | |
|--------------------|-------|------------------------|
| Part number: 86847 | 1L | Tin |
| Part number: 86848 | 5L | Tin |
| Part number: 86845 | 400ml | Cartridge |
| Part number: 86846 | 400ml | Aerosol |
| Part number: 86796 | 400ml | Lube Shuttle Cartridge |



AUTO GREASE WHITE

A high quality calcium based grease, specially formulated to provide visible lubrication.

- ✓ Calcium based - Impervious to water unlike lithium based competitors
- ✓ Superior adhesion - Will not run or slump
- ✓ Viscostatic - Retains properties over wide temp range

Part number: 84593 500ml Aerosol



WHITE GREASE 2

A semi-opaque (partially invisible) medium viscosity, calcium based multi-purpose grease. Excellent lubricating properties that protect against salt-water corrosion and is resistant to heat and cold.

- ✓ Calcium based - Impervious to water, unlike lithium based competitors
- ✓ Viscostatic - Retains properties over wide temp range
- ✓ No harmful solvents - Safe on virtually all components

Part number: 50071 500ml Aerosol



WHITE GREASE 3

A translucent, medium viscosity, calcium based multi-purpose grease. Excellent lubricating properties that protect against salt-water corrosion and is resistant to heat and cold conditions.

- ✓ Calcium based - Impervious to water, unlike lithium based competitors
- ✓ Excellent adhesion - Will not run or slump
- ✓ Slotted cap with extension nozzle

Part number: 50073 500ml Aerosol
Part number: 86727 (Easy Straw) 500ml Aerosol



RID RUST

A unique, high specification, multi-purpose penetrant and lubricant.

- ✓ PTFE based giving "non stick" properties - Silicone free
- ✓ Lubricates & protects parts & metals against acidity and road salts
- ✓ Displaces damp from electricals without affecting electrical integrity

Part number: 34410 500ml Aerosol



C1000

NSF approved assembly lubricant known as 'ceramic lubricant' used to assemble screwed parts, designed to withstand very high temperatures and used on ferrous and non-ferrous alloys.

- ✓ Very high temperature range : -25°to +1000°c
- ✓ Contains anti corrosion inhibitor -improves corrosion resistance
- ✓ Superior adhesion -Will not run or slump

Part number: 86779 200ml Tube



FOOD MULTI FUNCTION SPRAY

Many actions in one product. Penetrating, anti-seize, deoxidizing, anti-humidity, lubricating agent, tar remover, cleaning agent and diluting agent for inks. NSF approved.

- ✓ Clean, colourless, silicone-free multi-spray
- ✓ User-friendly, no chlorinated solvents
- ✓ NSF (H1) approved for incidental contact in food areas

Part number: 85810 400ml Aerosol



FOOD SAFE SILICONE SPRAY

NSF approved, highly versatile, non-corrosive formula lubricates, protects, waterproofs and restores a wide range of parts and equipment in food related areas.

- ✓ NSF H1 registered for incidental food contact (Reg. # 137994)
- ✓ Effective over a wide temperature range (-40°C to+200°C)
- ✓ Low surface tension for a better coverage and deeper penetration

Part number: 86623 400ml Aerosol



HI-TECH GREASE

An NSF approved, medium viscosity, synthetic based grease for lubrication in production areas.

- ✓ NSF approval to H1 - Safe to use for indirect food applications
- ✓ Resistant to salt, cold and warm water - Good corrosion protection
- ✓ Good solvent driven penetration - Easily penetrates areas difficult to access

Part number: 84526 400ml Aerosol
Part number: 85313 400g Cartridge



PTFE+ LUBRICANT

An NSF approved high quality, dual action, penetrating and lubricating oil with PTFE for automotive and industrial lubrication applications.

- ✓ NSF H1 registered - Safe for incidental food contact
- ✓ Penetrant and lubricant in one - Penetrates to leave a lubricant coating
- ✓ Contains PTFE - Long term lubrication, even after solvents have flashed off

Part number: 84065 500ml Aerosol
Part number: 85540 150ml Aerosol
Part number: 86720 (Easy Straw) 500ml Aerosol



KD400

A multi-purpose, clear, silicone free, non-staining lubricant that penetrates rust, displaces moisture and protects against rust and wear.

- ✓ Anti wear properties – helps reduce wear and tear
- ✓ Safe on rubbers and plastics – can be used with confidence
- ✓ Water resistant – protects against corrosion

| | | |
|---------------------------------|-------|---------|
| Part number: 50205 | 400ml | Aerosol |
| Part number: 85311 (Food grade) | 300ml | Aerosol |
| Part number: 86747 (Easy Straw) | 500ml | Aerosol |



SL500

A fast acting, penetrating grease for lubrication of general moving components subjected to high pressure, impact and vibration.

- ✓ Special formulation – thin while spraying, thick after flash off
- ✓ Transparent appearance – invisible protection
- ✓ High adhesion – stays where it is needed

| | | |
|---------------------------------|-------|---------|
| Part number: 84339 | 500ml | Aerosol |
| Part number: 86748 (Easy Straw) | 500ml | Aerosol |



91 IN 1

A unique PTFE-based fast acting multi-purpose penetrant and lubricant.

- ✓ Contains PTFE - Will not evaporate or freeze
- ✓ Outstanding capillary action - Penetrates fine tolerances, lubricate & protect
- ✓ Free of silicone, acid and resin - Does not harm painted surfaces or plastics

| | | |
|--------------------|-------|---------|
| Part number: 86376 | 500ml | Aerosol |
|--------------------|-------|---------|



DRY LUBE

A clear, PTFE based dry lubricant for plastic, rubber, metal and fabric.

- ✓ Totally Dry - Will not attract dust and dirt
- ✓ Clear non-staining - Will not damage soft trim
- ✓ Water resistant - Will not wash off

| | | |
|--------------------|-------|---------|
| Part number: 50180 | 400ml | Aerosol |
|--------------------|-------|---------|



RUSTY CLEAR

A unique, high specification, multi-purpose penetrant and lubricant.

- ✓ PTFE based giving “non stick” properties - Silicone free
- ✓ Lubricates and protects moving parts against atmospheric acidity, road salts
- ✓ Penetrates the finest tolerances - Free rusted, seized or corroded parts

Part number: 34605

500ml

Aerosol



RUSTY PENETRANT

A fast working, multi-purpose rust penetrant with graphite particles.

- ✓ Fast acting rust release - Saves time
- ✓ Contains graphite - Leaves lubricating film to reduce chances of “bolt shear”
- ✓ Breaks rust bond - Parts can be re-used

Part number: 83726

400ml

Aerosol

Part number: 86726 (Easy Straw)

500ml

Aerosol



RUSTY SHOCK

A multi-purpose rust penetrant with fast freezing abilities.

- ✓ Graphite based - Excellent lubricating abilities
- ✓ Freezes down to -40°C - Shocks components into releasing their bond
- ✓ First class penetration abilities - Penetrates into the component

Part number: 84599

400ml

Aerosol



CUT & DRILL FLUID 2

Designed for use in all cutting, tapping, drilling operations to extend the life and overall performance of cutting tools and improve surface finish.

- ✓ Helps provide an improved surface finish by reducing heat and friction
- ✓ Contains additives which prevent pitting, galling and metal seizures
- ✓ Suitable for all metals including stainless steel, titanium and aluminium

Part number: 85238

500ml

Aerosol



Z43

A water-resistant grease suitable for lubricating all machine parts, providing protection against rust and corrosion.

- ✓ Non-staining - Will not cause damage
- ✓ Non sticky finish - Very low dust attraction
- ✓ Good water resistance - Will resist wash off, no 'come-backs'

Part number: 50040

400ml

Aerosol



K44 SILICONE GREASE

Combines the unique properties of silicone oil with thixotropic agents to give a viscous grease.

- ✓ Wide temp. range -40 °C to +200 °C - Suitable for most auto components
- ✓ Good di-electric strength - Prevents arcing on electrics
- ✓ Excellent water repellency - Prevents water ingress into components

Part number: 86005

80ml

Tube



SILICONE GREASE

A high quality 100% silicone grease for lubrication / moisture protection.

- ✓ Does not run - Stays where it is applied
- ✓ Will not dry out or harden - Provides protection under adverse conditions
- ✓ Water resistant - Will not wash off

Part number: 34920

400ml

Aerosol

Part number: 86052

200ml

Pressure pack



SF100

A silicone based lubricant, protective film and moisture repellent.

- ✓ Clear lubricant coating - Invisible protection
- ✓ Protects plastics from discoloration - Maintains & restores to 'as new' finish
- ✓ Protects rubbers from cracking and perishing - Extends component life

Part number: 84517

500ml

Aerosol



MULTI PURPOSE LUBRICANT

Many actions in one. Plant based penetrating and lubricating fluid with raw materials free from hazardous substances.

- ✓ No petroleum hydrocarbon in formulation – HC, MOSH, MOAH free product
- ✓ Several features in 1 product : penetrant, anti wear, deoxidizer, release agent
- ✓ Non flammable CO2 propellant of natural origin - Safer to use

Part number: 86786

400ml

Aerosol



CHAIN LUBE 2

A high-tack lubricant for use under conditions of heavy loads and in dusty and contaminated environments. Will reduce friction noise and general wear and tear of the chain.

- ✓ Very high adhesion to chain - Does not fling
- ✓ Extreme pressure & anti-wear additives - Durable under heavy load
- ✓ Contains water repellent additives - Resistant to high pressure wash

Part number: 84182

400ml

Aerosol



MASKING



JAPANESE FLAT MASKING TAPE

Universal and easy to remove masking tape for general paint jobs.

- ✓ Leaves no residue when removed - No paint build up
- ✓ Fits curved surfaces / corners very well - Strong paper
- ✓ Excellent paint break line - No wrinkling or tearing

| | | |
|--------------------|------------|-----------------|
| Part number: 85778 | 6mm x 50m | Pack of 5 rolls |
| Part number: 85779 | 9mm x 50m | Pack of 5 rolls |
| Part number: 85780 | 12mm x 50m | Pack of 5 rolls |
| Part number: 85781 | 19mm x 50m | Pack of 3 rolls |
| Part number: 85782 | 25mm x 50m | Pack of 3 rolls |
| Part number: 85783 | 38mm x 50m | Pack of 3 rolls |
| Part number: 85784 | 50mm x 50m | Pack of 3 rolls |



MASKING TAPE

Suitable for applications requiring high temperature resistance.

- ✓ Good adhesion, even on irregular surfaces
- ✓ Heat resistant up to 80°C (30 minutes)
- ✓ Easy removal without adhesive residue (removed when paint is dry)

| | | |
|--------------------|------------|------------------|
| Part number: V2184 | 38mm x 50m | Pack of 24 rolls |
| Part number: V2185 | 50mm x 50m | Pack of 24 rolls |



PERFORATED TRIM MASKING TAPE

A high temperature crepe masking tape with a pressure sensitive adhesive. Perforated to aid dispensing.

- ✓ Perforated - No tools needed to cut the tape
- ✓ Easy Lifting Tab - Quick and easy to use
- ✓ One size Fits All - Reduces inventory

| | | |
|--------------------|------------|--------|
| Part number: 85385 | 50mm x 10m | 1 roll |
|--------------------|------------|--------|



ORANGE FINE LINE MASKING TAPE

For multi-colour and design paint jobs.

- ✓ Universal, for curves & straight lines - Non-wrinkle
- ✓ Flat lay down giving sharp paint lines - Non-crease
- ✓ Leaves no residue when removed - No paint build-up

| | | |
|-----------------------------------|------------|-----------------|
| Part number: 85720 | 3mm x 55m | Pack of 5 rolls |
| Part number: 85721 | 6mm x 55m | Pack of 5 rolls |
| Part number: 85722 | 9mm x 55m | Pack of 5 rolls |
| Part number: 85723 | 12mm x 55m | Pack of 5 rolls |
| Part number: 85740 (Starter pack) | | Pack of 6 rolls |

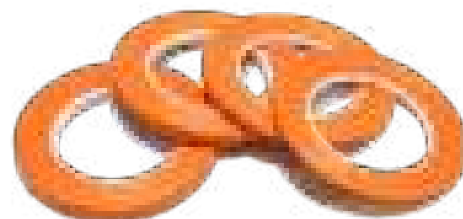

FLEXI NO EDGE BLENDING TAPE

Flexible foam with a pressure sensitive adhesive (NO crepe) masking tape giving it much more flexibility for masking curved style lines like wheel arches and panel edges to blend from old to new paintwork.

- ✓ Seamless blending from old to new paintwork – Avoids unnecessary rework
- ✓ Quick lay down and no residue on de-masking
- ✓ Suitable for infra-red



Part number: 86437

15mm x 5m

Pack of 5 rolls

NO EDGE BLENDING TAPE

A flexible foam combined with a crepe masking tape with a pressure sensitive adhesive. Designed for the masking of swage lines (like door apertures) and panel edges to blend from old to new paintwork.

- ✓ Seamless blending from old to new paintwork – Avoids unnecessary rework
- ✓ Quick lay down and no residue on de-masking
- ✓ Suitable for infra-red

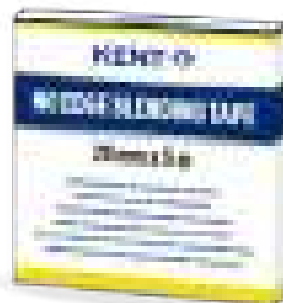

Part number: 85387

20mm x 5m

1 roll

ADVANCED FOAM MASKING TAPE

Designed for masking door apertures to stop the ingress of spray paint whilst being sprayed during repair.

- ✓ Door applications - One size fits all gaps
- ✓ Precise fingertip depth in gap adjustment
- ✓ Recessed Adhesive – No paint edge, no rubbing down



Part number: 85386

20mm x 50m

Pack of 10 rolls

PRIMERSHIELD FOAM MASKING TAPE

Double foam band for masking of openings and gaps.

- ✓ Dramatically reduces process times
- ✓ Seals and protects from overspray
- ✓ Precise fingertip adjustment of masking position



Part number: 85917

15mm x 21m

7 x 3m strips

ELECTROSTATIC PROTECTIVE FILM

Adheres statically to the vehicle to form a protective layer.

- ✓ Protection twice as fast as paper - Cover a whole vehicle in seconds
- ✓ Does not spangle on removal
- ✓ Highly resistant to breakdown



Part number: V2198

4m x 200m

1 roll

PLASTIC REPAIR



PREMIUM PU REPAIR (1.5 MIN & 3.5 MIN)

An easy to use structural 2-part polyurethane adhesive specially designed for small, quick, durable bonding and repair jobs on plastics and many other substrates.

- ✓ Excellent filling properties, doesn't sag while curing
- ✓ Very good flexibility, doesn't crack
- ✓ Doesn't peel off while sanding

| | | |
|------------------------------------|------|----------------|
| Part number: 86431 (1.5 min) | 50mm | Dual cartridge |
| Part number: 86432 (3.5 min) | 50mm | Dual cartridge |
| Part number: 86392 (Mixer nozzles) | | Pack of 6 |
| Part number: 86393 (Mixer nozzles) | | Pack of 50 |



TURBO & PREMIUM PU REPAIR L.E.

An optimal structural bonding and repairing of small scratches or cracks in plastics and many other substrates

- ✓ Bonds most plastics, metals, wood etc.
- ✓ 30 seconds, 1.5 and 3.5 minutes open time
- ✓ Does not sag or bubble while curing for a neat & professional finish

| | | |
|------------------------------------------|------|----------------|
| Part number: 86703 (30 sec) | 50ml | Dual cartridge |
| Part number: 86704 (1.5 min) | 50ml | Dual cartridge |
| Part number: 86705 (3.5 min) | 50ml | Dual cartridge |
| Part number: 87004 (1.5 min - white) | 50ml | Dual cartridge |
| Part number: 87005 (1 min - transparent) | 50ml | Dual cartridge |



TURBO PU REPAIR

A very fast curing, easy to use structural 2-part polyurethane adhesive specially designed for small, quick, durable bonding and repairs on plastics and many other substrates.

- ✓ 30 seconds open time – Very fast curing
- ✓ Bonds most plastics, metals, wood, etc - Universal
- ✓ Ultra small mixing nozzles - Less wastage of product

| | | |
|----------------------------------------|------|----------------|
| Part number: 86391 | 50ml | Dual cartridge |
| Part number: 86392 (TPR mixer nozzles) | | Pack of 6 |
| Part number: 86393 (TPR mixer nozzles) | | Pack of 50 |



PRR 2 RIGID

A 2K polyurethane plastic repair adhesive for rigid plastic repair in a dual cartridge for 1:1 mixing.

- ✓ Cures in 10 minutes (full cure in 4 hours) - Quick through-put in workshop
- ✓ Can be over-painted once cured - Compatible with all paint systems
- ✓ Sands well and produces smooth finish - Invisible repair

Part number: 84001

50mm

Dual cartridge

Part number: 84004 (Mixer nozzles)

Pack of 6



PLASTIC REPAIR TPO

A flexible polyurethane adhesive for repairing TPO plastics provided as a two part, 1:1 ratio product in a dual 50ml cartridge.

- ✓ Will adhere under extreme pressure - Impact resistance of original plastic
- ✓ Cures in 10 mins (full cure in 4 hours) - Allows quick through-put in workshop
- ✓ Sands well, produces smooth finish - Invisible repair

Part number: 84003

50mm

Dual cartridge

Part number: 84004 (Mixer nozzles)

Pack of 6



PLASTIC REPAIR MIXER TIPS

Static mixer nozzle for 2K plastic repair resin.

- ✓ Disposable after each use
- ✓ Contains less than 2 ml of product when full

Part number: 84004

Pack of 6



REINFORCEMENT PLASTIC FILM

Adhesive webbing for additional support on larger plastic repairs.

- ✓ Easy application
- ✓ Ensures smooth finish
- ✓ Speeds curing

Part number: 85099

13cm x 150cm

1.5m roll



ULTRA PLASTIC

A two-component filler with high fill, non-sag characteristics with excellent adhesion on a variety of substrates, especially plastics.

- ✓ Fast hardening - Improves throughput in workshop
- ✓ Excellent sandability - Ensures a fine, smooth finish
- ✓ Good adhesion on plastic and metal - Will not delaminate from substrate

Part number: 86598

1kg

Tin



PLASTIC ADHESION PROMOTER

1K ready to use adhesion promoter that can be applied on most plastics.

- ✓ Ready for use adhesion promoter - Improves adhesion on difficult substrates
- ✓ Can be applied on most plastics - Leaves a clear hazy film
- ✓ Quick drying - Clear and colourless

Part number: 85828

400ml

Aerosol



PLASTIC DRESSING

Plastic dressing is absorbed into the pores of the plastic and cures leaving an "as new" uniform dark colour film.

- ✓ Reconditions and protects - Restores colour to faded plastics
- ✓ Weatherproof - Will not wash off in rain
- ✓ Long lasting - Stays on bumper 3-4 weeks (climate dependant)

Part number: 34706

400ml

Aerosol



PLASTIC PREP

An effective solvent specially formulated for safe use in body shops to remove silicone, wax and grease residues.

- ✓ Cleans deep into pores - Improves the keying of coating products
- ✓ Quick flash off - Solvent does not affect adhesion of coatings
- ✓ No harsh effects on plastic

Part number: 34699 400ml Aerosol



PLASTIC PAINT

Aerosol paint in 4 colours for re-colouring plastic components.

- ✓ Suitable for most plastics - Use with confidence
- ✓ Quick and easy - No mixing required or wastage
- ✓ Excellent coverage with each coat - Saves time

| | | |
|---------------------------------|-------|---------|
| Part number: 83795 (Black) | 500ml | Aerosol |
| Part number: 83796 (Dark grey) | 500ml | Aerosol |
| Part number: 83797 (Mid grey) | 500ml | Aerosol |
| Part number: 83798 (Light grey) | 500ml | Aerosol |



ULTRAFILL 3

1K primer filler for applications on old paints, metallic and rigid plastic substrates without the need for adhesion agents.

- ✓ Superior adhesion to plastics and metals - convenient application
- ✓ Highly flexible and resistant to cracking and physical stress forces
- ✓ New resin technology - dramatically improves adhesion to PP composites

| | | |
|-----------------------------|-------|---------|
| Part number: 87051 (Black) | 500ml | Aerosol |
| Part number: 87052 (Grey) | 500ml | Aerosol |
| Part number: 87053 (White) | 500ml | Aerosol |
| Part number: 87054 (Red) | 500ml | Aerosol |
| Part number: 87055 (Blue) | 500ml | Aerosol |
| Part number: 87056 (Yellow) | 500ml | Aerosol |



QUICKFILL

Primer and filler to fill pores or small scratches.

- ✓ Very flexible - Flexes with plastic & metal components
- ✓ Extremely good coat depth with each pass - Good fill & build qualities
- ✓ Dries fast (20 minutes) - Saves time

Part number: 34363 500ml Aerosol



PLAZ TEX BLACK

Restores the original OEM finish of plastic surfaces.

Plaz Tex Black spray is suitable for most plastics and restores the original OEM finish of many brands and models. Repairs on plastic are often necessary in the cockpit or on bumpers but the repaired areas remain smooth afterwards and do not match the finish of the surrounding area. Plaz Tex Black first lets you repair the plastic as usual which can then be restored to its coarser finish. The product is economic in its use, features superb opacity and dries quickly. It is ideal for quick vehicle treatment in repair shops, car detailing outfits and maintenance projects. It is black in colour which lets you achieve a perfect finish.

It can be used for cosmetic repairs on: bumpers, spoilers, air dams, side-skirts, mirror housings and plastic wheel trims, holes in dashboards, centre consoles, plastic door panels and fascia trim to name but a few.

Typical customers who will find a use for this product will include: -

- Existing plastic repair customers
- Body Shops
- SMART repair specialists
- Used vehicle preparation sites
- Fleet repair specialists

Features and benefits

- ✓ Coarse textured paint - Matches many OEM finishes
- ✓ Suitable for most plastics - Use with confidence
- ✓ Fast drying - Allows quick through-put
- ✓ No wastage - Saves money
- ✓ Excellent coverage with each coat - Saves time
- ✓ Compatible with leading paint systems - No 'come-backs'

Part number: 86735

400ml

Aerosol



PLAZ TEX CLEAR 2

Allows the replication of the molded texturing on modern plastic bumpers, dashboards and other plastic fittings.

- ✓ Recreates OEM finish - Gives undetectable repair
- ✓ Fast drying - Quick throughput in workshop
- ✓ Suitable for most plastics - Use with confidence

Part number: 84586

400ml

Aerosol



PLASTIC CLEAN & PROTECT

A refinishing plastic spray without silicone suitable for all interior plastic parts.

- ✓ Produces glossy protective finish in one easy step
- ✓ Anti-static and repels dust – resists further dirt and dust build up
- ✓ Leaves a clean surface - no stains or greasy residues

Part number: 85447

500ml

Aerosol



LOGLIFE - EXTERIOR PLASTIC TREATMENT

A silicone free exterior plastic conditioner, solving the problem of badly stained or faded exterior plastics.

- ✓ Long lasting with no water/rain streaks
- ✓ Reconditions and protects
- ✓ Stays looking good even under wet road conditions

Part number: 85749

500ml

Bottle



MINI STAPLER KIT

THE solution for cracked or chipped plastic parts.

Cracked or chipped plastic parts on vehicles are very aggravating. Entire components often need to be replaced just to exchange an inconspicuous plastic part because it has developed a crack or a small clip has broken off. Plastic repair for example, of a bumper is much more economic. However, because merely bonding or filling is often not sufficient to withstand the material tension and future stresses the KENT Mini Stapler Kit is recommended. It allows you to give additional stability to the repaired parts by means of stainless steel staples.

Damages on plastic parts are diverse and frequent. Sometimes a plastic bumper needs to be repaired, sometimes brackets or clips have broken off and sometimes cracks in motorcycle trim need to be fixed. All these demands have one thing in common. Repairing the plastic part instead of replacing the affected piece is usually more economic and often even easier and quicker. The KENT Mini Stapler Kit for plastic repair lets you first reinforce plastic parts with high-quality stainless steel staples before filling or bonding the material. This allows repairing larger damages, and you can be sure that the durability of the material will not suffer from the repair. Thanks to the two power settings of the device, plastic repair will be successful even with especially thick or thin parts. The integrated LED light provides the illumination needed even in difficult, dim working conditions. The three angle bores permit working in difficult to access areas.

Features and benefits

- ✓ Cordless, compact and weighs only 200 grams
- ✓ Long rechargeable battery life for mobile use (approx 250 staples per charge)
- ✓ 2 power settings for different material thicknesses
- ✓ 3 angle positions (0° / 45° / 90°) for simple handling
- ✓ Including 8 types of staples with 20 pieces each (=160 staples)

Part number: 86355 (Complete kit)

Part number: 86356 (Mini Stapler)

Case

1 piece



PLASTIC REPAIR STAPLES



Stainless steel staples for the quick and efficient repair of plastic parts.

- ✓ Six different shapes - for any kind of plastic repair
- ✓ Two thicknesses - for thin and thick plastic parts
- ✓ Stainless steel - will not rust



| | | |
|---------------------------------------|-------|-------------|
| Part number: 86037 (W staples) | 0.6mm | Pack of 100 |
| Part number: 86038 (W staples) | 0.8mm | Pack of 100 |
| Part number: 86039 (S staples) | 0.6mm | Pack of 100 |
| Part number: 86040 (S staples) | 0.8mm | Pack of 100 |
| Part number: 86041 (V staples) | 0.8mm | Pack of 100 |
| Part number: 86279 (Double M staples) | 0.8mm | Pack of 100 |
| Part number: 86280 (Double V staples) | 0.8mm | Pack of 100 |
| Part number: 86358 (Large W staples) | 0.8mm | Pack of 100 |



Small repairs

| Staple | Size | Packaging (Art No.) |
|-------------------------------------------------------------------------------------|-------|----------------------|
| W Staple | | |
|  | 0.6mm | 100 units (86037 00) |
| | 0.8mm | 100 units (86038 00) |
| S Staple | | |
|  | 0.6mm | 100 units (86039 00) |
| | 0.8mm | 100 units (86040 00) |
| Y Staple | | |
|  | 0.8mm | 100 units (86041 00) |

Large repairs

| Staple | Size | Packaging (Art No.) |
|-------------------------------------------------------------------------------------|-------|----------------------|
| Large W | | |
|  | 0.8mm | 100 units (86358 00) |
| Double V | | |
|  | 0.8mm | 100 units (86280 00) |
| Double M | | |
|  | 0.8mm | 100 units (86279 00) |

POLISHES



PERFORMANCE POLISH RP (NANO)

Developed using a unique blend of fine Nano particles which provide superior protection with a long lasting shine.

- ✓ Penetrates tiny imperfections - Provides an even shiny finish
- ✓ Creates extra deep gloss - Excellent finish
- ✓ No water necessary - No mess, easy application

| | | |
|--------------------|-------|--------|
| Part number: 85396 | 500ml | Bottle |
| Part number: 85092 | 1L | Bottle |
| Part number: 85250 | 5L | Bottle |



PERFORMANCE COMPOUND 2

Completely removes nibs and fine flattening paint scratches permanently. Ideal for blending, matching of gloss levels, general paint restoration.

- ✓ No water necessary - No mess, easy application
- ✓ Non-spray formula - Not necessary to jet-wash after polishing
- ✓ Removal of scratches, not hiding imperfections - Better finish and gloss

| | | |
|--------------------|----|--------|
| Part number: 86606 | 1L | Bottle |
|--------------------|----|--------|



PERFORMANCE ABRASIVE 2

Specially formulated with extended running time to enable the operator to achieve enhanced cutting action with no drying out, delivering a high gloss final finish.

- ✓ No water necessary/non-spray - No mess and easy application
- ✓ Abrasive contains lubricants - Easier running of pad and no greasy film
- ✓ Removal of scratches, not hiding imperfections - Better finish and gloss

| | | |
|--------------------|----|--------|
| Part number: 86605 | 1L | Bottle |
|--------------------|----|--------|



MICROFIBRE CLOTHS

Multi-purpose cleaning cloths. Used dry, they remove dirt and dust (including the smallest dust particles) with static electricity. When moist they absorb dirt and grease leaving surfaces clean and smear free.

- ✓ Can be used on most surfaces - Very versatile
- ✓ Machine washable up to 500 times

| | | |
|--------------------------------------|-------------|-----------|
| Part number: 86343 (Finishing cloth) | 40cm x 40cm | Pack of 3 |
|--------------------------------------|-------------|-----------|

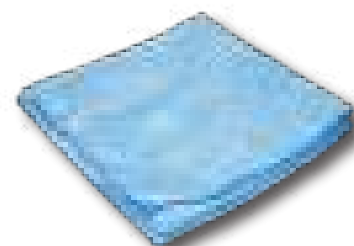

FAST CUT POLISH

Doesn't hide imperfections, scratches or holograms with oils, but removes them permanently. Best results with this system are achievable by orbital polishing machine and a interface pad.

- ✓ 2 in 1 compound depending on the pad used
- ✓ Ammonia & silicone free - bodyshop and paintshop safe
- ✓ Latest technology - Up to 3 x longer durability during polishing

Part number: 86415 1L Bottle
Part number: 86414 (Purple Foam Pad) 165mm x 32mm 1 pc



CERAMIC ABRASIVE POLISH

Blue abrasive polish, based on nanotechnology, developed to remove light paint defects such as sanding marks, scratches due to car-washing, paint oxidation, etc

- ✓ Ideal for anti-scratch ceramic paints – high glossy finish
- ✓ Fast action – easy to apply and buff
- ✓ 2 in 1: it removes sanding marks and polishes at the same time

Part number: 85422 500ml Bottle



ANTI HOLOGRAM

Superfine polish for the permanent removal of holograms and sanding marks, which leaves a particularly high shine.

- ✓ 100% removal of scratches from P2000 onwards
- ✓ Low product consumption – Economical in use
- ✓ Low VOC content – More environmentally and user friendly in terms of VOC

Part number: 86960 1L Bottle



TRAPEZIUM FOAM PAD

Perfectly suitable for P2000 scratches and finishes to very high gloss in one step by orbital & rotary polishers

- ✓ A perfect match for KENT Anti Hologram
- ✓ Super durable and long lasting
- ✓ Helps achieve stunning results

Part number: 86968 1 pc



ULTIMATE SERIES POLISHING PADS

A range of superior quality foam and wool polishing pads.

- ✓ A wide range of pads covering nearly every application
- ✓ Exceptional quality and performance

| | | |
|--------------------------------------|-------|------|
| Part number: 85920 (Lambswool) | 150mm | 1 pc |
| Part number: 85923 (White - HARD) | 150mm | 1 pc |
| Part number: 85924 (Orange - MEDIUM) | 150mm | 1 pc |
| Part number: 85925 (Black - SOFT) | 150mm | 1 pc |



PRIMERS & COATINGS



ULTRAFILL 3

1K primer filler for applications on old paints, metallic and rigid plastic substrates without the need for adhesion agents.

KENT Ultrafill 3 uses state of the art hybrid resin technology to provide exceptional adhesion to PP composites and other rigid plastics, as well as zinc galvanized steel, aluminum and other sensitive substrates.

It is fully compatible with the latest generation of water-based refinishing paints and solvent-based paints. The acidic nature of the product ensures excellent adhesion to metallic surfaces by virtue of an acid-etching action.

Features and benefits

- ✓ Superior adhesion to plastics and metals - convenient application
- ✓ New resin technology - dramatically improves adhesion to PP composites
- ✓ Minimal in-can settlement results - instant ball release and easier mixing
- ✓ Highly flexible and resistant to cracking and physical stress forces
- ✓ Increased paint viscosity, reduced solvent thinner - smooth matt finish
- ✓ High dome valve - reduces impingement on the valve cup
- ✓ Improved aerosol formula, propellant blend, actuator
- ✓ Acid etching action - ensures optimal adhesion to metallic substrates.

| | | |
|-----------------------------|-------|---------|
| Part number: 87051 (Black) | 500ml | Aerosol |
| Part number: 87052 (Grey) | 500ml | Aerosol |
| Part number: 87053 (White) | 500ml | Aerosol |
| Part number: 87054 (Red) | 500ml | Aerosol |
| Part number: 87055 (Blue) | 500ml | Aerosol |
| Part number: 87056 (Yellow) | 500ml | Aerosol |



CROSS HATCH TEST DIN ISO 2409

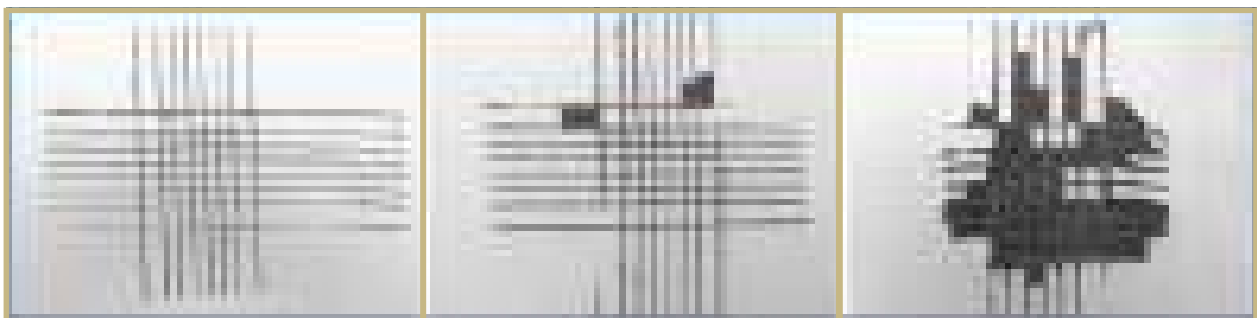

Ultrafill 3

Extraordinary performance on PP + EPDM with no pre-treatment

Ultrafill 2

Good performance on PP + EPDM with no pre-treatment

Standard Product

Low performance on PP + EPDM with no pre-treatment

SPOT PRIMER

A quick drying, universal aerosol primer suitable for small, sanded-through spots.

- ✓ Fast drying, excellent adhesion, easy sandability
- ✓ Good filling properties, good flexibility, good hardness
- ✓ Due to the zinc phosphate, it can be used directly on metal

| | | |
|----------------------------|-------|---------|
| Part number: 86334 (Black) | 400ml | Aerosol |
| Part number: 86335 (Grey) | 400ml | Aerosol |
| Part number: 86336 (White) | 400ml | Aerosol |



QUICKFILL

A high solid content primer and filler to fill pores or small scratches.

- ✓ Extremely good coat depth with each pass - Good fill and build qualities
- ✓ Good adhesion to many surfaces - No 'come-backs'
- ✓ Dries fast (20 minutes) - Saves time

| | | |
|--------------------|-------|---------|
| Part number: 34363 | 500ml | Aerosol |
|--------------------|-------|---------|



ETCH PRIMER

A 1K ready to use chromate free etch primer. It is used for priming of bare metal surfaces which promotes adhesion of paint and prevents corrosion on steel.

- ✓ One component product - No mixing required
- ✓ Excellent adhesion to many metal surfaces - Versatile applications
- ✓ Compatible with most paint systems - Use with confidence, no 'come-backs'

| | | |
|--------------------|-------|---------|
| Part number: 83270 | 450ml | Aerosol |
|--------------------|-------|---------|



EPOXY PRIMER

All purpose primer with excellent adhesion. Prevents corrosion from aluminium, anodised aluminium, sheet steel & zinc coated steel.

- ✓ Excellent adhesion and protection - Product will not run, prevents corrosion
- ✓ Quick drying time - Overpaintable after 12-15 minutes @ 20 degrees
- ✓ Wet-on-wet application possible - Time saving

| | | |
|--------------------|-------|---------|
| Part number: 86375 | 500ml | Aerosol |
|--------------------|-------|---------|



GRAPHENE PRIMER

Supreme surface protection against corrosion that forms exceptionally strong adhesion for years

- ✓ Remarkable corrosion protection - 1750+ hours salt spray test
- ✓ Unusually fast drying - overpaintable after 20 minutes
- ✓ Anti-sag properties - to achieve high coat depths

Part number: 87057 (Dark Grey)
Part number: 87058 (Grey)

500 ml
500 ml

Aerosol
Aerosol



Exceptional performance put to the test!

To underline the remarkable performance of the new Graphene Primer technology, we took it to the **ASTM G-85 salt spray test – with tremendous results:**

| | 168 hrs | 336 hrs | 432 hrs | 696 hrs | 1000 hrs | 1750 hrs | |
|--|---------|---------|---------|---------|----------|----------|--|
|--|---------|---------|---------|---------|----------|----------|--|

Rust coming up when using standard primer without graphene

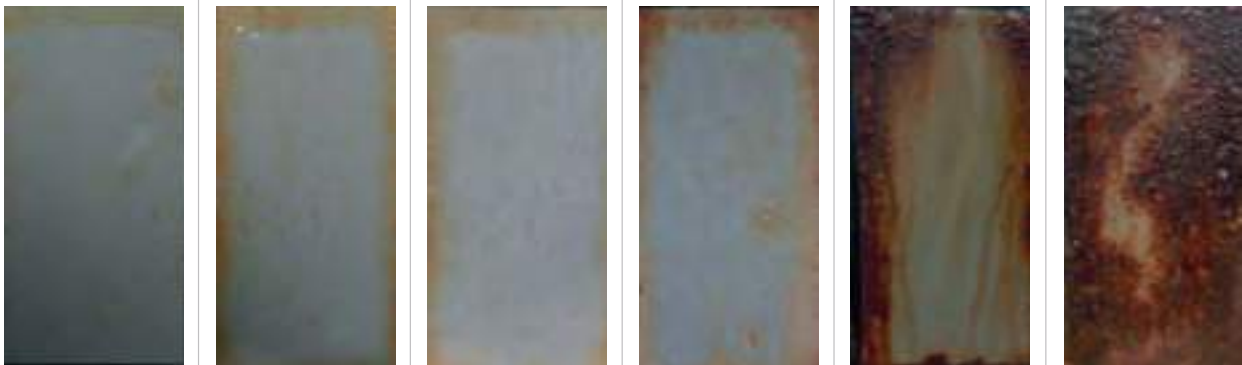

Best resistance against corrosion with KENT Graphene Primer!

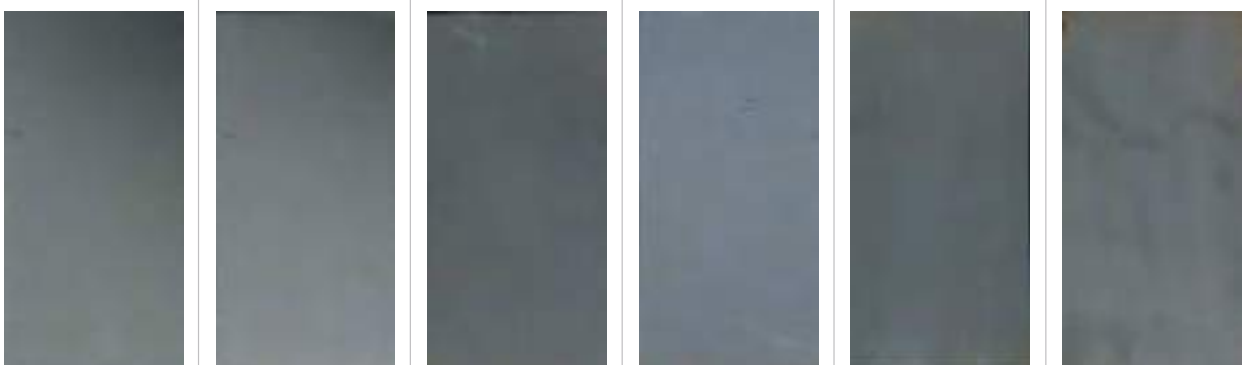

WELDPRIME

Ideal for priming seams prior to spot or MIG welding, providing a rust preventative coating.

- ✓ Excellent adhesion to intermediate/top coats - Forms strong corrosion barrier
- ✓ One part product - Easy spray application
- ✓ Can be over-painted with most paints - No 'come-backs'

Part number: 50190

400ml

Aerosol



COPPER WELDPRIMER

Ideal for priming seams prior to spot or MIG welding, providing a protective coating.

- ✓ High solid content - Excellent coat depth gives greater corrosion protection
- ✓ Very good electrical conductivity - Easy MIG striking / electrode contact
- ✓ Decreases welding spatter & protects panel - Neat finish, less clean-up

Part number: 86354

500ml

Aerosol



GALVAPRO

Developed specially to protect and prime panels prior to over-painting, Galvapro is a fast drying weldable galvaniser with excellent film coverage and finish.

- ✓ Excellent adhesion to metal surfaces - Product will not run
- ✓ Quick drying time - Can be over-painted within 30 minutes
- ✓ Good conductivity - Ideal for spot and shielded arc welding

Part number: 34547

400ml

Aerosol



CONSTRUCTION PRIMER

A 1K aerosol, air drying primer with a smooth matt finish formulated to have excellent anti-corrosion, adhesion properties and to be flexible.

- ✓ Excellent adhesion / salt spray resistance - Durable and weather resistant
- ✓ Flexible with high mechanical strength - Use on flexible plastic surfaces
- ✓ Fast drying - Quick and easy to use

Part number: 86183

500ml

Aerosol



ZINC ALU SPRAY

Glossy, zinc-based cathodic protection corrosion primer.

- ✓ Can be spot-welded, compatible with nearly all paints
- ✓ Strong bond and easy to paint over
- ✓ Excellent finish with semi-silver pigments

Part number: 85479

400ml

Aerosol



NEW SELF GUIDE

A state of the art primer filler that combines fast drying properties with easy handling for a more efficient and safer primer process.

- ✓ 200% more filling power and faster curing - saves time and money
- ✓ Double & faster hardening - provides a basecoat absorption free surface
- ✓ Extremely fast drying - 10 min by 60°C reducing energy costs

Part number: 86767 (Grey)

3.75L

Part number: 86768 (Black)

3.75L

Part number: 86767 (White)

3.75L

Part number: 86770 (Hardener)

1L

Part number: 86771 (Fast Hardener)

1L



SELF GUIDE PRIMER FILLER EVO

An innovative, acrylic, high solid, two-component primer/ filler with a 4:1 mixing ratio. Available in standard colours (black, grey and white).

- High solid content – Creates high build, which can be adjusted by adjusting the percentage of thinners
- Immediately matches the colour, even with finishes which contain clear pigments – Can easily be covered with 95% of paints, even those that usually require an undercoat
- Easy to sand – Direct sanding with P320 / P400 grit. Finish with P500 / P600 grit for light colours
- Changes colour during sanding (black turns into neutral grey) – Acts as a guide coat avoiding use of spray matt black. Also highlights defects not usually seen with coloured fillers
- Excellent drying – Easily sandable without clogging the abrasive paper

Part number: 85814 (Black)

3.75L

Part number: 85815 (Light Grey)

3.75L

Part number: 86171 (White)

3.75L

Part number: 85816 (Hardener)

1L

Part number: 85694 (Thinner)

1L

Part number: 85756 (Ipercure/Accelerator)

500ml



ULTRA UV PRIMER

Fast drying UV primer for filling and insulating a wide variety of substrates, such as paints, metal, plastic and wood

- ✓ 2K finish in 2 minutes – Extremely fast drying and highly resistant primer
- ✓ No cooling down before sanding – increases productivity and output
- ✓ LED UV curing – reduces energy costs compared to oven curing

Part number: 86840 400ml Aerosol



UV CLEANER

Special cleaning agent for removal of the adhesive layer of the Ultra UV-Primer after UV curing.

- ✓ Quick flash-off
- ✓ Special solvents ensure effective cleaning
- ✓ Designed to work perfectly with KENT Ultra UV Primer

Part number: 86895 400ml Aerosol



PLASTIC ADHESION PROMOTER

1K, ready to use adhesion promoter that can be applied on most automotive and household plastics.

- ✓ Ready for use adhesion promoter - Improves adhesion on difficult substrates
- ✓ Apply on most automotive and household plastics - Leaves a clear hazy film
- ✓ Quick drying - Clear and colourless

Part number: 85828 400ml Aerosol



AEROSOL SPRAY PAINTS

A range of general purpose acrylic based paints.

- ✓ Excellent covering power - Covers large area, cost efficient
- ✓ Superb resistance to sunlight / colour fade - Does not require touch-up
- ✓ First class adhesion to primed surfaces - Good consistent surface coating

Part number: 86243 (Gloss Black) 500ml Aerosol
Part number: 86244 (Satin Black) 500ml Aerosol
Part number: 86245 (Matt Black) 500ml Aerosol
Part number: 86246 (Gloss White) 500ml Aerosol



PLASTIC PAINT

A range of aerosol paints for re-colouring plastic components.

- ✓ Suitable for most plastics - Use with confidence
- ✓ Excellent coverage with each coat - Saves time
- ✓ Compatible with leading paint systems - No 'come-backs'

| | | |
|---------------------------------|-------|---------|
| Part number: 83795 (Black) | 500ml | Aerosol |
| Part number: 83796 (Dark Grey) | 500ml | Aerosol |
| Part number: 83797 (Mid Grey) | 500ml | Aerosol |
| Part number: 83798 (Light Grey) | 500ml | Aerosol |



BODY FINISH PAINT

A very high-quality and fast drying 1-component acrylic lacquer specially developed to spray new or repaired sheet metal as well as parts of machines giving them an OEM finish.

- ✓ Superior covering capability and excellent bond
- ✓ Outstanding anti-corrosion properties
- ✓ Dust-dry after 10 minutes

| | | |
|----------------------------|-------|---------|
| Part number: 85987 (Grey) | 500ml | Aerosol |
| Part number: 85988 (Green) | 500ml | Aerosol |
| Part number: 85989 (Beige) | 500ml | Aerosol |

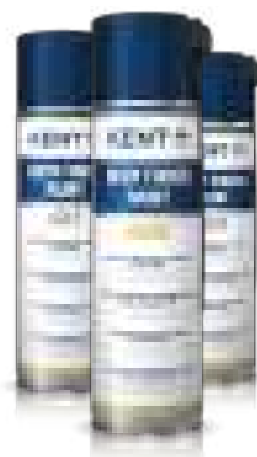

HT PAINT

A fast drying, high temperature resistant paint. Ideal for exhausts, grilles and other engine parts.

- ✓ Superb corrosion protection up to 600°C - Extends life of engine parts
- ✓ Weather resistant - Long-lasting coating
- ✓ Excellent adhesion - No primer needed

| | | |
|-----------------------------|-------|---------|
| Part number: 86826 (Black) | 400ml | Aerosol |
| Part number: 86827 (Silver) | 400ml | Aerosol |



MATT BLACK SPRAY

A fast-drying paint with good adhesion.

- ✓ Can be sprayed directly onto all plastic surfaces without using a primer
- ✓ Excellent finish
- ✓ Good adhesion on most components parts

| | | |
|--------------------|-------|---------|
| Part number: 85480 | 400ml | Aerosol |
|--------------------|-------|---------|



WHEEL SPRAY

An acrylic silver paint for restoring the appearance of wheel rims and decorative wheel covers.

- ✓ Excellent coverage on steel, aluminum, nylon and most plastics - Time saving
- ✓ Replicates OEM finish - Professional repair
- ✓ Acrylic resin based product - Resistant to oil and petrol

Part number: 86519

500ml

Aerosol



WHEEL RIM SILVER

A high gloss silver paint for restoring the appearance of wheel rims and decorative wheel covers.

- ✓ Good adhesion - Perfect results on all metals incl. aluminium & most plastics
- ✓ High quality aluminum pigments - High silver gloss finish
- ✓ Replicates OEM finish - Professional repair

Part number: 84329

400ml

Aerosol



STAINLESS HCR

High heat and corrosion resistant powdered stainless steel alloy coating.

- ✓ Provides a tough, durable, fast drying coat - Protects against corrosion / heat
- ✓ Flexible film with UV resistance - Resists peeling and discoloring
- ✓ Matt stainless steel finish - Finish comparable with original stainless surface

Part number: 16040

592ml

Aerosol



RUST CONVERTER (AERO)

Ensures a uniform and sustainable conversion of corroded patches and thus forms with a stable foundation for subsequent coatings.

- ✓ Easy and uniform application - fast drying
- ✓ No brush or other tools needed - fail safe application
- ✓ Excellent sandability - no clogging

Part number: 86878

500ml

Aerosol



RUST CONVERTER

A mineral acid-free rust treatment formulated to neutralise corrosion on ferrous metals and components. Also acts as a primer coating, ready for over-coating as desired.

- ✓ Neutralises corrosion and leaves a solid coat
- ✓ Minimum surface preparation required
- ✓ Easy to apply with brush, roller or spray attachment

Part number: 86277

500ml

Bottle



HS CLEARCOAT ANTI-SCRATCH

A new generation HS 2K clear coat made with acrylic co-polymer resins, with low VOC, compatible with all standard painting systems and with a good surface resistance to scratches.

- ✓ Resists scratches and impacts from small stones – Maintains excellent finish
- ✓ Excellent atmospheric / UV resistance - Does not yellow or peel with ageing
- ✓ High solid formulation, excellent flow - Use on large and small areas

Part number: 85690 (Clear Coat)

5L

Tin

Part number: 85691 (Fast Hardener)

2.5L

Tin

Part number: 85692 (Medium Hardener)

2.5L

Tin

Part number: 85693 (Slow Hardener)

2.5L

Tin

Part number: 85694 (Thinners)

1L

Tin

Part number: 85756 (Ipercure)

500ml

Tin



FINAL CLEAR

A 1K high performance clear coating that gives a 2K performance finish.

- ✓ 1K aerosol - No mixing and spraying equipment needed
- ✓ Excellent build & superb gloss finish - Time saving
- ✓ UV resistant finish guaranteed - Peace of mind for customer

Part number: 84110

450ml

Aerosol



2K CRYSTAL CLEAR

Crystal clear, extremely durable, chip/UV resistant high gloss clear coat

- ✓ 2K ready to use technology - No activation required
- ✓ Extremely durable - Chemical, UV and scratch resistant
- ✓ Forms a deep and shiny surface - No risk of dripping

Part number: 86892

400ml

Aerosol



LACQUER REPAIR SPRAY

A 1k aerosol for dissolving edges of 2k paints to give an invisible blend.

- ✓ Dissolves clear coat masking edges - No need for 2k fading
- ✓ Gives a soft edge to repairs - Time saving
- ✓ Suitable for MS and HS clear coats - Reduces inventory

Part number: 84125

500ml

Aerosol



SPRAY GUIDE

Fast drying, dry powder, sanding guide coating.

- ✓ Can be used for both wet and dry sanding - Reduce products in stock
- ✓ Used to highlight low spots and imperfections - Time saving
- ✓ Quick drying - Time saving

Part number: 84120

450ml

Aerosol



LIGHTS CLEAR COAT KIT

3K kit renews and restores brightness of any plastic/polycarbonate/makrolon car lights. Surfaces return to their original transparency and scratches (even deep ones) are removed. Long lasting protection.

- ✓ Excellent adhesion to PC plastics and organic glasses
- ✓ Prevent yellowing of surfaces
- ✓ Does not affect mechanical resistance of plastics

Part number: 85792

Kit (3 bottles)



TIGHTER BOND PRIMER

Developed specially to improve the adhesion on difficult surfaces.

- ✓ High compatibility - Works on a variety of substrates including most plastics
- ✓ Economical - Apply directly to required area
- ✓ Easy to use - Impressive performance

Part number: 34586

250ml

Tin



WAXCOAT

A cavity wax coating, specifically developed to penetrate even into the most inaccessible areas.

- ✓ Film thickness of 20 - 40 microns - Excellent resistance to road conditions
- ✓ Compatible with recently painted surfaces - Won't damage fresh cured paint
- ✓ Quick drying - Saves time

| | | |
|---------------------------------------|-------|---------|
| Part number: 34488 | 500ml | Aerosol |
| Part number: 84465 | 1L | Can |
| Part number: 84466 (Extension nozzle) | | 1 piece |



TRANSPARENT WAXCOAT

A wax based coating, providing excellent anti-corrosion properties for cavity areas or surfaces needing rust protection.

- ✓ Self-healing properties - Resists damage, provides long lasting protection
- ✓ High penetrating ability - Penetrates and coats difficult to reach areas
- ✓ No dripping, one hour after application - Use with confidence

| | | |
|--------------------|-------|---------|
| Part number: 86160 | 1L | Can |
| Part number: 86161 | 500ml | Aerosol |



UNDERBODY WAX

Thixotropic wax based coatings. Excellent anti-corrosion properties.

- ✓ Excellent corrosion protection - Treated area resilient to the environment
- ✓ Self-healing properties - Protects against stone-chip damage
- ✓ Good adhesion properties - Can be used with confidence

| | | |
|----------------------------|-------|---------|
| Part number: 86156 (Black) | 1L | Can |
| Part number: 86157 (Brown) | 1L | Can |
| Part number: 86158 (Black) | 500ml | Aerosol |
| Part number: 86159 (Brown) | 500ml | Aerosol |



RUBBER GUARD

A heavy duty aerosol, coarse textured underseal that protects against corrosion and stone chipping.

- ✓ Heavy bodied - Excellent coverage, even with one coat
- ✓ Wide temperature range -40° C to +135° C - Withstands extreme conditions
- ✓ Over-paintable - Compatible with most paint systems

| | | |
|--------------------|-------|---------|
| Part number: 50110 | 577ml | Aerosol |
|--------------------|-------|---------|



STONE CHIP COATING

Over-paintable stone chip coating with anti corrosion and sound deadening properties based on rubber and resins.

- ✓ Very good adhesion to a wide dried range of substrates
- ✓ Good resistance against various climates and stone chips
- ✓ Durable elastic film remains after the product has dried

Part number: 85481 (Black) 500ml Aerosol
Part number: 85483 (Grey) 500ml Aerosol



TOUGHCOAT

A paintable, tough, hard, durable stone chip finish which also works as a sound deadening coating.

- ✓ One coat coverage - Saves time and money
- ✓ Fast Paint over - Lightweight formula
- ✓ Replicates most OEM finishes - Professional repair

Part number: 86721 (Black) 1L Bottle
Part number: 86722 (Grey) 1L Bottle
Part number: 86723 (White) 1L Bottle



UNDERBODY SPRAY GUN

A shutz style gun for use with underbody and rust protection treatments in standard 1 litre containers.

- ✓ Multi use tool - Shutz gun and blow air gun in one
- ✓ Blow gun clips on to shutz adaptor - Saves time
- ✓ Fast changeover - No need to remove and clean dip tubes

Part number: 86190 (Gun) 1 piece
Part number: 86191 (Nozzles) Pack of 3



WATER BASED UNDERBODY & STONE-CHIP

Provides an elastic film which protects against corrosion, stone-chip damage and salt.

- ✓ Fresh material can be removed with warm water - no solvents necessary
- ✓ Excellent adhesion & corrosion protection - Very good durability
- ✓ Replicates most OEM finishes - Professional repair

Part number: 86374 1L Can





KENT

SOUND DEADENING PADS

20x 500 x 250 x 2mm

| | | |
|--------------------------------------------------|----------------------------------------------------|-----------------------------------------------------------------------|
| Plafes insonorizantes | Self Adhesive / Flexible without heating / Pánadlá | Schallfömmatten |
| Azuleiros / Ayudas al suelo / Plafes de portes | | Ebden ohne Aufkleben / Oberackerbor |
| Fibra Aia acusticizante | | Piastra insonorizanti |
| Likens / Plafes acusticizante / Gerspüler | | Azuleiro / Plafes acusticizante / Versicibile |
| Schallfömmatten | | Lámina amortiguadora de sonido |
| Schallfömmatten / Plafes acusticizante / Acustic | | Azuleiros / Se aplican sin necesidad de calentarse / Se pueden pintar |

INSTRUCCIONES DE USO:

1. Limpieza y desengrasado de la superficie.
2. Aplicación de la pasta adhesiva.
3. Aplicación de la lámina.
4. Eliminación de los residuos.

NOTAS:

1. Este producto es un adhesivo de alta resistencia.
2. No aplicar sobre superficies que estén húmedas o con grasa.
3. Evitar el contacto con agua o productos químicos.
4. Mantener el producto en un lugar seco y ventilado.

INSTRUCCIONES DE MONTAJE:

1. Aplicar la pasta adhesiva sobre la superficie.
2. Aplicar la lámina sobre la pasta.
3. Presionar la lámina para asegurar el contacto.
4. Eliminar los residuos.

INSTRUCCIONES DE DESMONTAJE:

1. Aplicar un disolvente sobre la lámina.
2. Esperar a que se haya disuelto el adhesivo.
3. Retirar la lámina.
4. Limpiar la superficie.

NOTAS:

1. Este producto es un adhesivo de alta resistencia.
2. No aplicar sobre superficies que estén húmedas o con grasa.
3. Evitar el contacto con agua o productos químicos.
4. Mantener el producto en un lugar seco y ventilado.

INSTRUCCIONES DE MONTAJE:

1. Aplicar la pasta adhesiva sobre la superficie.
2. Aplicar la lámina sobre la pasta.
3. Presionar la lámina para asegurar el contacto.
4. Eliminar los residuos.

INSTRUCCIONES DE DESMONTAJE:

1. Aplicar un disolvente sobre la lámina.
2. Esperar a que se haya disuelto el adhesivo.
3. Retirar la lámina.
4. Limpiar la superficie.

PI/N°: 34452 33 S/C: SDP

4 00057 7012630

QR CODE

WWW.KENTADHESIVE.COM

CONTACTO:

TEL: +34 938 30 00 00

EMAIL: INFO@KENTADHESIVE.COM

SPECIALIST PRODUCTS

ABRAPREP

A pre-paint flattening paste and one-step water based abrasive cleaning and preparation system.

- ✓ 3-in-1 saves time, triple-action - Abrades, cleans and completely degreases
- ✓ Consistent, even key - Enhances coating adhesion
- ✓ Uniform matting/cleaning action gives the perfect key in hard-to reach areas

Part number: 85754

362ml

Bottle



BELT DRESSING

A grip improver and re-conditioner for drive belts. Restores flexibility and improves power transmission.

- ✓ Elastomeric conditioners protect the belt from oxidation, drying / hardening
- ✓ Improves power transmission by halting belt slippage
- ✓ Anti-slip frictioner provides positive gripping action between belt and pulley

Part number: 86502

400ml

Aerosol



TEKCHEK

A white powder spray giving a fast, positive way to locate wind, water and dust leaks on fixed glass, vehicle boots and door apertures.

- ✓ User can pinpoint the exact leak area quickly
- ✓ Silica-based - Leaves no wet, chalky residue
- ✓ Propellant flashes off quickly - Dries within seconds

Part number: 34362

300ml

Aerosol



SOUND DEADENING PADS

Flexible laminated sound damping pads made of a mixture of bitumen, co-polymers and fillers designed to give extremely good flexibility with ease of application to all areas of the motor vehicle.

- ✓ Highly flexible - Apply to flat, curved or waved surfaces
- ✓ Self-adhesive - Will adhere to bare and painted metals
- ✓ High noise suppression characteristics - Reduce airborne / impact noises

Part number: 34652

50cm x 25cm

Pack of 20



SG15

A friction gel that is designed to assist in the removal of stripped or damaged screw heads and other fixings.

- ✓ Can be used on crosshead, phillips, torx, allen heads etc - Multi-use product
- ✓ Increases torque between 400-800% - Makes removing fixings easy
- ✓ Can also be used on rounded-off nuts - Wide range of applications

Part number: 86087

15ml

Bottle



HEATSHIELD GEL

An easily applied gel to prevent heat damage to sensitive areas when undertaking repairs where high temperatures are involved, such as in welding operations.

- ✓ Will prevent or reduce heat distortion of materials such as metal
- ✓ Protects coated surfaces and sensitive materials from heat or flame damage
- ✓ Non-toxic, non-corrosive and biodegradable - Safe to use

Part number: 84145

907ml

Spray bottle



LEAK DETECTOR SPRAY

A micro porous foam which indicates the position of the smallest gas leaks instantly.

- ✓ Safe on many surfaces - Use with confidence
- ✓ Quickly identifies leak area - Saves time and money
- ✓ Non-flammable - Safe to use with flammable gases

Part number: 84597

400ml

Aerosol



SENSOR GEL

Two-component transparent silicone gel allowing the re-use of round-type rain and light sensors. It quickly cures at ambient temperature, therefore no expensive heating box is required.

- ✓ One syringe will fill one big round sensor or two small round sensors
- ✓ Quick and easy to apply, old sensor can be reattached in just a few minutes
- ✓ No heat source or heating box are required, cures in only 5 minutes at 23°C

Part number: 86377

5ml

Syringe



EXPANDING FOAM

A two component polyurethane foam that expands with approximately a 10 to 1 ratio and cures to form a rigid closed cell foam.

- ✓ Fast curing/hardening - Saves time
- ✓ Liquid state during extrusion - Penetrates and fills difficult to reach areas
- ✓ Over paintable - Quality Finish

Part number: 84511 (Grey)

50ml

Dual cartridge

Part number: 84508 (White)

50ml

Dual cartridge

Part number: 84004 (Mixer Tips)

Pack of 6



TYRE FITTING GEL - EASY STRAW

Innovative tyre fitting gel for easier mounting and de-mounting of tyres

- ✓ Quick flash off allowing no slip of rim on tyre once fitted
- ✓ Zero shiny stain - leaves no grease or mess after application
- ✓ Allows easier fitting of unusual hard to mount tyres like of run-flats,

Part number: 86745

500ml

Easy Straw





**TOOLS, ACCESSORIES
& CONSUMABLES**

MULTI GUN

An air-powered spray sealer gun for re-creating various finishes inline with OEM appearance. Ideal to use with Proseal 303, Proseal 404 and other sealants. Designed to use standard cartridges up to 320ml.

- ✓ Very easy to use; especially around wheel arches / difficult to reach areas
- ✓ Easily adjustable spray pattern
- ✓ Nozzle is easy to change; one screw to replace it



Part number: 84325
Part number: 84788 (Mixed Nozzles)

Gun
Pack of 20

HAND CAULKING GUN

Heavy duty construction manual operation cartridge gun for all standard plastic and metal cartridges.

- ✓ Quick installation and removal of cartridges
- ✓ High quality construction - Built to last
- ✓ Ergonomically designed for comfortable use



Part number: 34775

1 piece

AIR CAULKING GUN

Lightweight aluminium air caulking guns for use with standard plastic and metal cartridges and 400ml foil sausages.

- ✓ Built-in pressure regulator at the base of the handle
- ✓ Maximum working pressure of 10 bar / 145 psi / 10.2 kgf/cm²
- ✓ Quick installation and removal of cartridges / sausages



Part number: 34894 (Cartridge)
Part number: 83400 (Foil Sausage 400ml)

1 piece
1 piece

SAUSAGE GUN

Pneumatic applicator for the extrusion of sealers and adhesives, packaged in 300/400/600ml sausages.

- ✓ Integrated pressure reducer
- ✓ Integrated dump valve (dripless)
- ✓ Maximum thrust: 160 Kg (8 bar) – 1569 kN



Part number: 34775

1 piece

BATTERY CAULKING GUN

Professional cordless applicator for extrusion of sealant products in standard plastic and metal cartridges as well as 300/400ml sausages.

- ✓ Supplied in sturdy handy case for convenience and protection
- ✓ Powerful lithium-ion battery you can rely on to get the job done
- ✓ Quick Charger with a charging time of 90 mins

| | | |
|--------------------|---------------|------|
| Part number: 87060 | 400ml gun | 1 pc |
| Part number: 87061 | 600ml gun | 1 pc |
| Part number: 87062 | Spare battery | 1 pc |
| Part number: 87063 | Spare charger | 1 pc |



RATCHET HAND GUN 26:1

A 26:1 ratio, dual and single component applicator gun.

- ✓ Suitable for high viscosity pastes and liquids giving more than 5kn of trust
- ✓ Designed for all 310ml cartridges & universal 250ml/280ml two components
- ✓ Ergonomic design- Comfortable and easy to use

Part number: 86538 1 piece



2K DISPENSER GUN

Professional hand gun for 1:1 and 2:1 adhesives in 50 ml dual cartridges

- ✓ Long lasting - Will last for hundreds of cartridges
- ✓ For 1:1 and 2:1 adhesives in 50 ml cartridges - One gun only
- ✓ High extrusion ratio - No efforts needed to extrude the product

Part number: 86659 1 piece



2K DISPENSER GUN 220ML

Applicator gun for 1:1 adhesives in 220ml dual cartridges

- ✓ Premium, heavy duty construction
- ✓ Highly ergonomic design- a pleasure to use
- ✓ Ideal for KENT 220ml adhesives / sealers

Part number: 86759 1 piece



SCHUTZ GUN

A general schutz type air gun for applying vehicle body underseal.

- ✓ Built to last - Won't let you down
- ✓ Ergonomic design- Comfortable and easy to use
- ✓ Ideal for KENT Toughcoat

Part number: 34483

1 piece



LUBE SHUTTLE GUN

A new side-lever grease gun for Lube-Shuttle® cartridges, high quality version with zinc plated all-steel pumphead

- ✓ Simple, quick and completely clean loading and removal of grease cartridges
- ✓ No need to bleed anymore; virtually no problems caused by air
- ✓ Fill level and grease type can be constantly checked from the outside

Part number: 86795

1 piece



PLASTIC SPRAY BOTTLE

A durable plastic spray bottle designed with a hand grip for comfortable handling. The nozzle adjusts to give a fine mist or a penetrating jet.

- ✓ Holds 600ml of liquid
- ✓ Capable of both a fine mist spray and a penetrating jet
- ✓ Graduated in 50ml divisions for accurate mixing

Part number: 30190

1 piece



SOLVENT RESISTANT PUMP SPRAYER

Ideal for all professional spraying applications. Resistant to a wide range of solvents, brake cleaners, degreasers, detergents, diluted alkali and acids.

- ✓ Environmentally friendly way to spray bulk liquids
- ✓ Adjustable nozzle fine spray to jet spray
- ✓ Resistant to wide range of chemicals and solvents

Part number: 85737

1 piece



PLASTIC WINDSHIELD STICK

High quality plastic spatula for general workshop use.

- ✓ Premium quality
- ✓ Supremely versatile

Part number: 34515

1 piece



MIXING PALLET

Clean, contamination-free surface to mix fillers.

- ✓ 50 disposable sheets - Economical
- ✓ Ergonomically designed and sturdy backing board permits ease of mixing
- ✓ Improves repair quality and workshop efficiency

Part number: 83329

1 pad (50 sheets)



FEATHERING BRUSH

A solvent resistant, long bristle brush for feathering body seam sealers.

- ✓ High quality, lightweight design
- ✓ Ergonomic and comfortable in the hand

Part number: 70524

1 piece



RAZOR BLADE

Single-sided carbon steel razor blade with an aluminium spine. Ideal for general cutting and scraping duties in workshops and body shops.

- ✓ Bulk pack - Very economical
- ✓ Each blade is individually sleeved to protect them during transit

Part number: 83836

38mm x 19mm

Pack of 100



PROBIT

Long life, spot weld removal cutting tool.

- ✓ Self-centring point - No 'walking' or damage to adjacent panel area
- ✓ No pilot hole required - Saves time
- ✓ Heavy duty flute - Highly durable



| | | |
|--------------------|------|-----------|
| Part number: 34478 | 8 mm | 1 piece |
| Part number: 48733 | 6 mm | Pack of 5 |
| Part number: 43782 | 8 mm | Pack of 5 |

SPLIT POINT DRILL BITS

A precision ground twist drill made of cobalt alloyed special steel for tough and hard materials

- ✓ Cobalt coating gives increased tool life – saves time and money
- ✓ Ground from solid stock – high resistance against breaking forces
- ✓ Acute angle of 135°– reduced wear and provides a very good chip removal

| | | |
|--------------------|--------|-------|
| Part number: 87011 | 1 mm | 10 pc |
| Part number: 87012 | 1.5 mm | 10 pc |
| Part number: 87013 | 2 mm | 10 pc |
| Part number: 87014 | 2.5 mm | 10 pc |
| Part number: 87015 | 3 mm | 10 pc |
| Part number: 87016 | 3.3 mm | 10 pc |
| Part number: 87017 | 3.5 mm | 10 pc |
| Part number: 87018 | 4 mm | 10 pc |
| Part number: 87019 | 4.2 mm | 10 pc |
| Part number: 87020 | 4.5 mm | 10 pc |
| Part number: 87021 | 5 mm | 10 pc |
| Part number: 87022 | 5.5 mm | 10 pc |
| Part number: 87023 | 6 mm | 10 pc |
| Part number: 87024 | 6.5 mm | 10 pc |
| Part number: 87025 | 6.8 mm | 10 pc |
| Part number: 87026 | 7 mm | 10 pc |
| Part number: 87027 | 7.5 mm | 5 pc |
| Part number: 87028 | 8 mm | 5 pc |
| Part number: 87029 | 8.5 mm | 5 pc |
| Part number: 87030 | 9 mm | 5 pc |
| Part number: 87031 | 9.5 mm | 5 pc |
| Part number: 87032 | 10 mm | 5 pc |
| Part number: 87033 | 11 mm | 5 pc |
| Part number: 87034 | 12 mm | 5 pc |
| Part number: 87035 | 13 mm | 5 pc |

| | | |
|--------------------|------------------------------|-------|
| Part number: 87036 | 1 mm - 10 mm | 10 pc |
| Part number: 87037 | 3 x 1 mm, 3 x 2 mm, 4 x 3 mm | |
| Part number: 87038 | 5 x 4 mm, 5 x 5 mm | |

| | | |
|--------------------|--------------|-------|
| Part number: 86967 | 1 mm - 10 mm | 19 pc |
|--------------------|--------------|-------|



SPLIT POINT DRILLS

SIZE GUIDE

| | | |
|-----------------|---------------------|--------------------------------------------------------------------------------------|
| Part No - 87011 | 1 mm - pack of 10 |  |
| Part No - 87012 | 1.5 mm - pack of 10 |  |
| Part No - 87013 | 2 mm - pack of 10 |  |
| Part No - 87014 | 2.5 mm - pack of 10 |  |
| Part No - 87015 | 3 mm - pack of 10 |  |
| Part No - 87016 | 3.3 mm - pack of 10 |  |
| Part No - 87017 | 3.5 mm - pack of 10 |  |
| Part No - 87018 | 4 mm - pack of 10 |  |
| Part No - 87019 | 4.2 mm - pack of 10 |  |
| Part No - 87020 | 4.5 mm - pack of 10 |  |
| Part No - 87021 | 5 mm - pack of 10 |  |
| Part No - 87022 | 5.5 mm - pack of 10 |  |
| Part No - 87023 | 6 mm - pack of 10 |  |
| Part No - 87024 | 6.5 mm - pack of 10 |  |
| Part No - 87025 | 6.8 mm - pack of 10 |  |

Tools, Accessories & Consumables



Part No - 87026 7 mm - pack of 10



Part No - 87027 7.5 mm - pack of 5



Part No - 87028 8 mm - pack of 5



Part No - 87029 8.5 mm - pack of 5



Part No - 87030 9 mm - pack of 5



Part No - 87031 9.5 mm - pack of 5



Part No - 87032 10 mm - pack of 5



Part No - 87033 11 mm - pack of 5



Part No - 87034 12 mm - pack of 5



Part No - 87035 13 mm - pack of 5

QUAD-CUT DRILL BITS HSS

A drill designed to specifically meet the needs of the maintenance/repair professional.

- ✓ Greater diameter to length ratio - Amazing stability/control & break less
- ✓ Ideal for a wide range of metals (very hard to very soft)
- ✓ 135° Quad-Cut point eliminates need for centre punch and doesn't walk
- ✓ Specially contoured flute speeds chip removal and penetrates metal easier
- ✓ Black oxide treated - Longer tool life, anti-rust, dissipates heat

| | | |
|--------------------|---------|-----------|
| Part number: 85888 | 1 mm | Pack of 5 |
| Part number: 85889 | 1.5 mm | Pack of 5 |
| Part number: 85890 | 2 mm | Pack of 5 |
| Part number: 85891 | 2.5 mm | Pack of 5 |
| Part number: 85892 | 3 mm | Pack of 5 |
| Part number: 85893 | 3.2 mm | Pack of 5 |
| Part number: 85894 | 3.5 mm | Pack of 5 |
| Part number: 85895 | 4 mm | Pack of 5 |
| Part number: 85897 | 4.2 mm | Pack of 5 |
| Part number: 85896 | 4.5 mm | Pack of 5 |
| Part number: 85898 | 5 mm | Pack of 5 |
| Part number: 85899 | 5.5 mm | Pack of 5 |
| Part number: 85900 | 6 mm | Pack of 5 |
| Part number: 85901 | 6.5 mm | Pack of 3 |
| Part number: 85902 | 7 mm | Pack of 3 |
| Part number: 85903 | 7.5 mm | Pack of 3 |
| Part number: 85904 | 8 mm | Pack of 3 |
| Part number: 85905 | 8.5 mm | Pack of 3 |
| Part number: 85906 | 9 mm | Pack of 3 |
| Part number: 85907 | 9.5 mm | Pack of 3 |
| Part number: 85908 | 10 mm | Pack of 3 |
| Part number: 85914 | 10.5 mm | Pack of 2 |
| Part number: 85909 | 11 mm | Pack of 2 |
| Part number: 85915 | 11.5 mm | Pack of 2 |
| Part number: 85910 | 12 mm | Pack of 2 |
| Part number: 85916 | 12.5 mm | Pack of 2 |
| Part number: 85911 | 13 mm | Pack of 2 |



CLEAR NOZZLE

For Quick Seal/Rotabond

Part number: 34199

Pack of 12



PRECUT NOZZLE

For Screenfix

Part number: 34087

Pack of 12



SAUSAGE NOZZLE

For Screenfix

Part number: 83401 (Standard)
Part number: 83402 (V-Cut)

1 piece
1 piece



FLAT BEAD NOZZLE

For Quick Seal/Rotabond

Part number: 85265

1 piece



MIXED NOZZLES

For use with Multi-Gun

Part number: 84788

Pack of 20

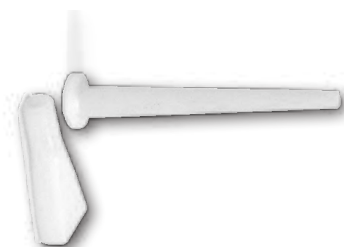

FAN NOZZLES

Wide fan nozzle for aerosol cans

Part number: 85735 (Red)

Pack of 12

Part number: 86870 (Blue)

Pack of 12

Part number: 86627 (Black)

Pack of 12



PLASTIC REPAIR MIXER TIP

For Rigid/TP0/Premium PU

Part number: 86392

Pack of 6

Part number: 86393

Pack of 50



MIXER NOZZLES 50ML

For Rapid Bond 50 ml dual cartridge

Part number: 86031

Pack of 12

Part number: 87068

Pack of 50



MIXER NOZZLES 25ML

For 2K Super Bond

Part number: 86684

Pack of 10



MIXING NOZZLES

For 2K Epoxy Panel Bond

Part number: 87059

Pack of 3

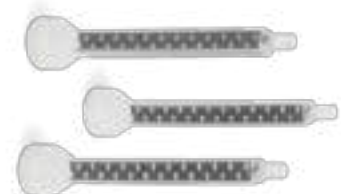

BRUSH APPLICATOR

For Ceramic 1200

Part number: 84346

Pack of 1



REPLACEMENT NOZZLES FOR SPRAY GUN

A shutz style gun for use with underbody and rust protection treatments in standard 1 litre containers

Part number: 86191

Pack of 3



WAXCOAT NOZZLE

Extra nozzle for Waxcoat

Part number: 84900

Pack of 1



EXTENSION NOZZLE

Long plastic tube/nozzle for underbody wax.

- ✓ High quality, consistent performance
- ✓ Essential for getting those 'hard to reach' areas on a vehicle

Part number: 86172

1 piece



SYPHON PUMP

For easy dispensing of liquids from 25L and 200L drums.

- ✓ Solid, high quality construction you can depend on
- ✓ Ergonomic and easy to use

Part number: 85772

1 piece

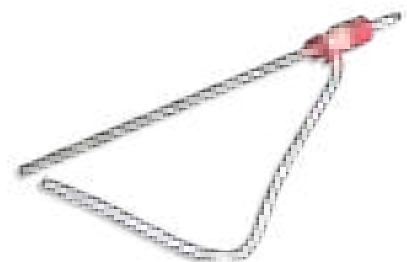

KNOW YOUR **NOZZLES**

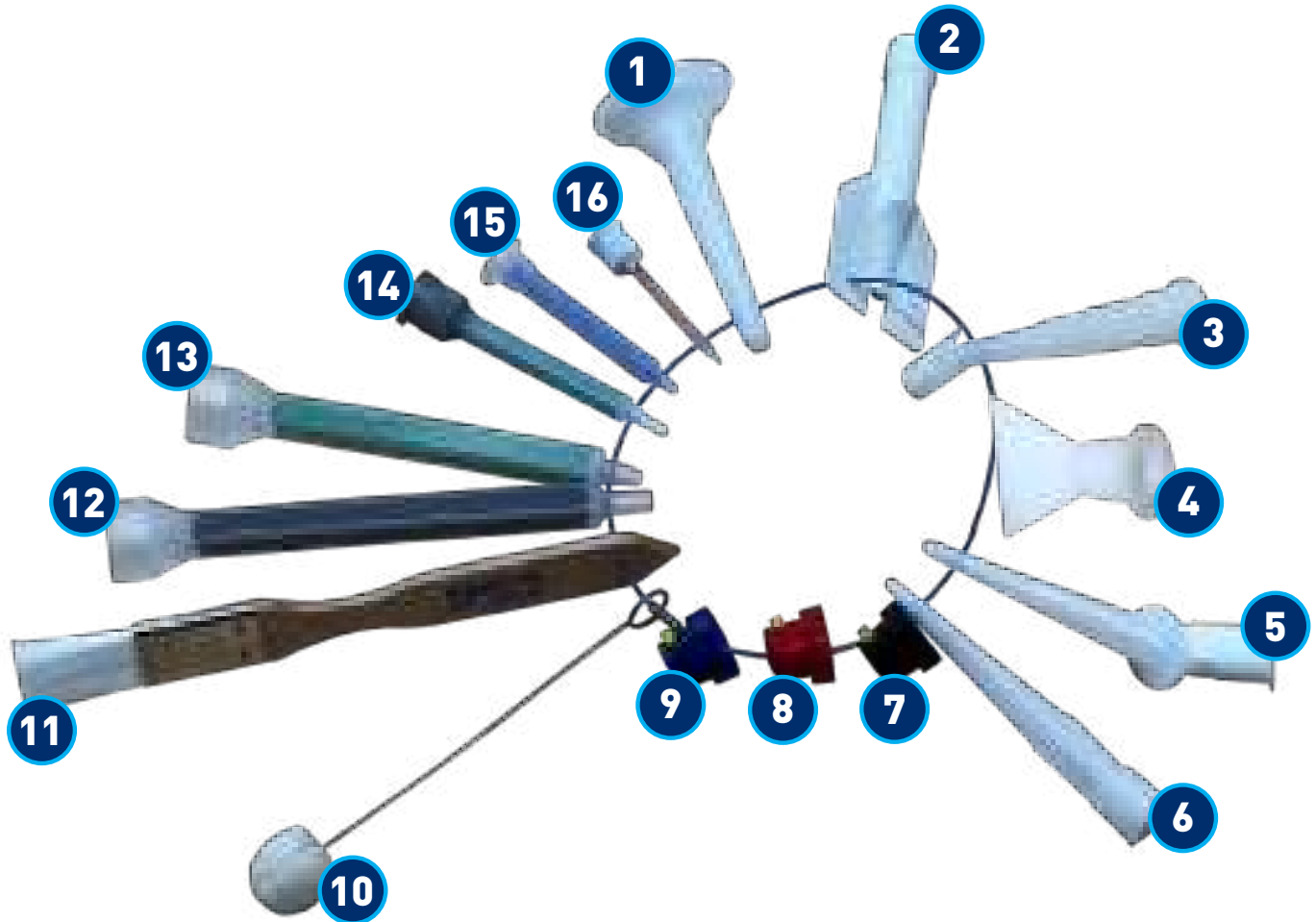

| | | | | | | | |
|-----------|---------------------------------------------------------|-----------|-------------------------------------------------------|-----------|-------------------------------------------------------------------------|-----------|---------------------------------------------------------|
| 1 | Ribbed Seam Nozzle P/N: 86667 00 - pack of 12 | 2 | Flat Bead Nozzle P/N: 85265 00 - 1 pc | 3 | Smart Seam Nozzle P/N: 86435 00 - pack of 12 | 4 | Flat Stream Nozzle P/N: 86885 00 - pack of 10 |
| 5 | 360 Degrees Nozzle P/N: 86007 00 - pack of 10 | 6 | Clear Nozzle P/N: 34199 00 - pack of 12 | 7 | Black Fan Nozzle P/N: 86627 00 - pack of 12 | 8 | Red Fan Nozzle P/N: 85735 00 - pack of 12 |
| 9 | Blue UFL Nozzle P/N: 86870 00 - pack of 12 | 10 | Premium Daubers P/N: E0201 00 - pack of 100 | 11 | Feathering Brush P/N: 70524 00 - 1 pc | 12 | 2K Epoxy Panel Bond P/N: 86511 00 - pack of 3 |
| 13 | Rapid Bond 220ml P/N: 86752 00 - pack of 6 | 14 | V2 Nozzles P/N: 86031 00 - pack of 12 | 15 | Mixer Tips P/N: 86393 00 - pack of 50 86392 00 - pack of 6 | 16 | 2K Super Bond P/N: 86684 00 - pack of 10 |

VALETING



NANO WASH & WAX

A low foam and silicone free shampoo using nano technology.

- ✓ Rapid drying - Gives faster vehicle turnaround
- ✓ Wax sheeting effect - Avoids water spotting
- ✓ Super economical - Only 15ml required in 5L of water

Part number: 85745 5L Container



WASH & WAX CAR SHAMPOO

A superlative silicone free wash & wax manual shampoo for luxury fast-lane cleaning of cars, coaches, caravans etc.

- ✓ Super action - Cleans and shines paintwork in one easy action
- ✓ Economical in use - Concentrated power
- ✓ Environmentally friendly - Complies with EC biodegradability criteria

Part number: 85743 5L Container



UPHOLSTERY CLEANER

A unique, highly concentrated cleaner suitable for use on upholstery, carpets and plastic surfaces.

- ✓ Dilute 1 part with 30 parts water - Economical in use
- ✓ Suitable for fabric, carpets and plastic - One cleaner for many applications
- ✓ Non-acidic, non-caustic formulation - Safe to use

Part number: 85450 5L Container



CLEANER AND SPOTTER

A professional cleaner and spotter for removing grease and stubborn stains on dry cleanable fabrics and carpets.

- ✓ Lifts stubborn stains (oil, grease, tar)
- ✓ Quick drying - Saves time
- ✓ Trichloroethane free

Part number: 34691 500ml Aerosol



NEW ALL PURPOSE FOAM CLEANER

A multi-use foam cleaner with a wide spectrum of applications. It can be used on soft and hard surfaces and is designed to quickly and easily produce a sparkling, smear free finish.

- ✓ Does not contain D'Limonene – No skin sensitisation, safe on most surfaces
- ✓ Non-staining, leaves no residue – Streak-free clean, radiant shine on glass
- ✓ Silicon free – Body Shop safe

Part number: 84909

750ml

Aerosol



MULTI CLEANER

A unique, water based cleaner that can be used on a wide variety of surfaces ranging from fabrics to plastic bumpers. It quickly penetrates and lifts away grime and dirt.

- ✓ Economical – Can be diluted 4 to 1 for lightly soiled surfaces
- ✓ Will not damage painted surfaces - Safe to use
- ✓ Easy to use – Spray on, wipe-off or rinse with water

Part number: 80260

1L

Bottle

Part number: 80261

5L

Container



SPRAY WAX

A premium detailing wax polish developed from a blend of naturally occurring waxes to give optimum durability, and a highly water-resistant glossy finish

- ✓ Contains Carnauba and Bees Wax - for durability and shine
- ✓ Contains silicone polymer – easy spreading & highly water-resistant barrier
- ✓ High gloss finish – non-abrasive Easy spray on / wipe off application

Part number: 86637

500ml

Aerosol



SPRAY WAX ZERO

A silicone free detailing polish based on naturally occurring waxes

- ✓ Silicone free - 100% paintshop safe
- ✓ Advanced wax technology - improved colour depth and mirror-like shine
- ✓ Highly water and dirt resistant - long lasting surface protection

Part number: 86837

500ml

Aerosol



SHOWROOM GLAZE

Anti-static, streak-free, high-gloss professional showroom glaze.

- ✓ Anti-static formula contains no wax, petroleum or silicone - Body Shop safe
- ✓ No scratch or streak formulation - Easy to use
- ✓ Safely removes dust, fingerprints and light water spotting - Versatile

Part number: 84954

500ml

Bottle



LONG LASTING SHINE

A specially developed polish based on nano technology which produces a clean, high gloss finish with no halos or swirls

- ✓ Fast polishing action – leaves no residues or halos
- ✓ High gloss finish - provides long-lasting protection
- ✓ Brilliant results on dark surfaces - doesn't leave swirl marks or stains

Part number: 85403

500ml

Bottle



NANO GRAPHENE COATING

Graphene based high gloss multi-surface protective coating.

- ✓ Long lasting - delivers 365 days of protection to treated surfaces
- ✓ Ultimate Beading - forms strong chemical bond to paintwork / substrates
- ✓ Incredible high-slip finish - 'Lotus-Leaf' effect repels water & dirt build-up

Part number: 87072

200ml

Flairosol®



PLASTIC CLEAN & PROTECT

A refinishing plastic spray without silicone suitable for all interior plastic parts.

- ✓ Produces glossy protective finish in one easy step
- ✓ Anti-static and repels dust – Resists further dirt and dust build up
- ✓ Leaves a clean surface - No stains or greasy residues

Part number: 85447

500ml

Aerosol



PLASTIC DRESSING

Plastic dressing is absorbed into the pores of the plastic and cures leaving an “as new” uniform dark colour film.

- ✓ Reconditions and protects - Restores colour to faded plastics
- ✓ Weatherproof - Will not wash off in rain
- ✓ Long lasting - Stays on bumper 3-4 weeks (climate dependant)

Part number: 34706

400ml

Aerosol



LOGLIFE - EXTERIOR PLASTIC TREATMENT

A silicone free exterior plastic conditioner, solving the problem of badly stained or faded exterior plastics.

- ✓ Long lasting with no water/rain streaks
- ✓ Reconditions and protects
- ✓ Stays looking good even under wet road conditions

Part number: 85749

500ml

Aerosol



GLASS KLEEN 2

A foam cleaner that quickly removes greasy film, insects and nicotine from glass and painted surfaces.

- ✓ Dissolves grease - Leaves a clean surface
- ✓ Unique formulation - No streaking or smearing on glass
- ✓ Quick Drying - Saves time

Part number: 85098

500ml

Aerosol



TOPDRESS - WATER BASED TYRE DRESSING

Water based and silicone free.

- ✓ Simple to Use - Simply trigger spray on to clean surface and allow to dry
- ✓ Superb original finish - Dries to a satin sheen 'as new' finish
- ✓ Non-staining - Dressing will not mark showroom carpets

Part number: 85752

5L

Container



TYRE DRESSING

Unique cleaning formulation that imparts a natural sheen and rejuvenates tyres in one easy application.

- ✓ Water repellent finish - Resists weathering, protects against contaminants
- ✓ Natural long lasting sheen - Won't wash off, prevents drying and cracking
- ✓ Non-hazardous - User friendly

Part number: 86952

400ml

Aerosol



WHEEL RIM SILVER

A high gloss silver paint for restoring the appearance of wheel rims and decorative wheel covers.

- ✓ Very good adhesion to a variety of substrates - Great results on most plastics
- ✓ High quality aluminum pigments - High silver gloss finish
- ✓ Replicates OEM finish - Professional repair

Part number: 84329

400ml

Aerosol



WHEEL SPRAY

An acrylic silver paint for restoring the appearance of wheel rims and decorative wheel covers.

- ✓ Excellent coverage on steel, aluminum, nylon and most plastics - Time saving
- ✓ One component product - No mixing, easy to use
- ✓ Replicates OEM finish - Professional repair

Part number: 86519

500ml

Aerosol



ALLOY WHEEL CLEANER

An effective solution for the removal of brake dust and staining from alloy, painted steel and plastic trim wheels. It will remove baked on brake dust and discolouration as well as general road dirt.

- ✓ Fast and efficient
- ✓ Safe non-aerosol formulation
- ✓ Designed to clean, protect and restore the 'new look'

Part number: 83200

500ml

Bottle

Part number: 83201

5L

Container

Part number: 86782 (Trigger Spray)

1 piece



WHEEL CLEANING BRUSH

A unique wheel cleaning brush, with forward angled bristles to allow agitation of wheel cleaning solutions into difficult access areas.

- ✓ Reduce cleaning time & effort
- ✓ Cost effective solution

Part number: 85765

1 piece



DASHBOARD WIPES

Clean, absorb dirt and leave an anti-static coating in one single operation, resisting further dirt and dust built-up.

- ✓ Absorbs dirt and provides an anti-static finish in one single operation
- ✓ Powerful cleaning solution cuts through dust, dirt and residues
- ✓ 50 wipes per dispenser tub

Part number: 83223

50 Wipes

Tub

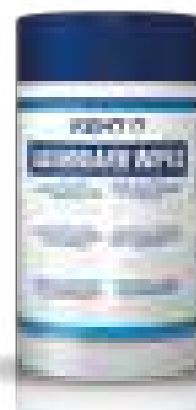

SPONGES

For the professional application of KENT Longlife Exterior Plastic Conditioner.

- ✓ Sized to be genuinely useful
- ✓ Speed up workflow
- ✓ Cost effective solution

Part number: 85755

Pack of 4



LARGE SPONGES

An easy to hold, highly absorbent, long lasting, trade proven sponge.

- ✓ Highly absorbent
- ✓ Long lasting
- ✓ Speed up workflow

Part number: 85762

Pack of 6



HI ABSORBENT SYNTHETIC LEATHER

Gives all the professional benefits of a real chamois leather: high water absorbency, excellent surface cleaning AND no residual water spotting.

- ✓ Highly absorbent - Washable
- ✓ Long lasting - Dries surfaces effortlessly
- ✓ Speed up workflow - Extra large size

Part number: 85764

54cm x 44cm

1 piece

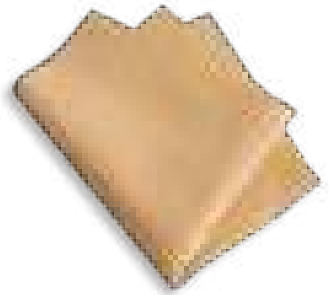

VENT AIR FRESHENERS

Leave vehicles smelling clean and fresh.

- ✓ Clip-on vent - Easy to use
- ✓ Pack of 12 pieces - Brilliant value
- ✓ Long lasting - Vehicle smells great for weeks

Part number: 85630 (Spicy Apple)

Part number: 85979 (Vanilla)

Part number: 86013 (Summer Breeze)

Pack of 12

Pack of 12

Pack of 12





WELDING

CERTANIUM 707T

Ultra high quality crack resistant dissimilar steel TIG wire.

- ✓ Crack free deposits - Quality repair
- ✓ Suitable for all weldable steels - Reduced inventory

Part number: 24056 (4kg)

1.6mm

Tub

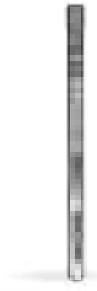

CERTANIUM 889SP

All position electrode for cast iron repair and joining and welding cast iron to steel.

- ✓ All position rod - Saves time in disassembling for repair
- ✓ Will weld mild steels - Ideal for joining dissimilar base metals
- ✓ No pre-heating required - Saves time

Part number: 22001 (4kg)

2.4mm

Tub

Part number: 22003 (4kg)

3.2mm

Tub

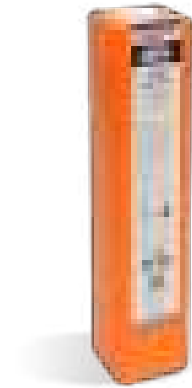

CERTANIUM 707SP

Universal all position, high strength alloy for repair and joining of all weldable steels.

- ✓ Compatible with all steels including stainless - Weld any steel with confidence
- ✓ Stable arc, even at low amps - Easy to use
- ✓ Welds through contaminants and rust - Saves time in preparation

Part number: 23013 (4kg)

2mm

Tub

Part number: 23010 (4kg)

2.5mm

Tub

Part number: 23011 (4kg)

3.2mm

Tub

Part number: 23012 (4kg)

4mm

Tub

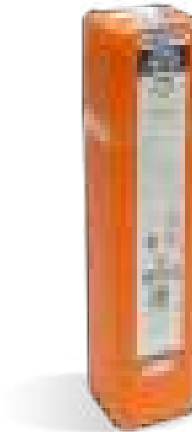

CERTANIUM 701

All position mild steel maintenance alloy.

- ✓ Compatible with all mild steels - Weld with confidence
- ✓ Stable arc, even at low amps - Saves preparation time
- ✓ Flat bead shape - Improved wetting action

Part number: 22798 (5kg)

2.4mm

Tub

Part number: 22804 (5kg)

3.2mm

Tub

Part number: 22807 (5kg)

4mm

Tub



CERTANIUM 707SP GOLD

Ultra high quality crack resistant dissimilar steel electrode.

- ✓ All position AC/DC coated electrode - Weld without dis-assembly
- ✓ Crack free deposits - Quality repair
- ✓ Superior performance on limited input AC machines

| | | |
|--------------------------|-------|-----|
| Part number: 84270 (4kg) | 2.4mm | Tub |
| Part number: 84271 (4kg) | 3.2mm | Tub |
| Part number: 84272 (4kg) | 4mm | Tub |



CERTANIUM 34C

An instant freeze, high strength alloy solder expressly designed for stainless steels and joining all metals, except light metals.

- ✓ Contains no lead, copper, antimony, zinc or cadmium
- ✓ Leaves a smooth and shiny finish, ideal for stainless steel and chrome plate
- ✓ 5 times as strong as a normal solder: 13 kg/mm²
- ✓ High resistance to corrosion

| | | |
|--------------------|-----|------|
| Part number: 86758 | 31g | Coil |
|--------------------|-----|------|



HEATSHIELD GEL

An easily applied gel to prevent heat damage to sensitive areas when undertaking repairs where high temperatures are involved, such as in welding operations.

- ✓ Will prevent or reduce heat distortion of materials such as metal
- ✓ Protects coated surfaces and sensitive materials from heat or flame damage
- ✓ Non-toxic, non-corrosive and biodegradable - Safe to use
- ✓ Spray application - Easy to use

| | | |
|--------------------|-------|--------------|
| Part number: 84145 | 907ml | Spray bottle |
|--------------------|-------|--------------|





WINDSCREEN

SCREENFIX

A superior, isocyanate free, high modulus, low conductive MS Polymer windscreen adhesive available in four drive-away times.

Work on vehicle windscreens often represents a challenge even for professional repair shops. Glass is a sophisticated material and must be managed carefully to satisfy maximum safety requirements. This applies especially to the secure bonding of windscreens into the vehicle frame. Care and caution from the experts comes into play here, but also professional equipment and accordingly, a high-quality windscreen adhesive. With Screenfix, KENT offers a top quality product with maximum reliability which is easy to process and at the same time, compatible with people and the environment.

Screenfix is a high-module single component adhesive on the basis of silane-modified polymers (SMP). Contrary to conventional polyurethane adhesives (PU) these polymers do not contain isocyanates and are therefore much safer for people's health and also for the environment. At the same time, SMPs are also distinguished by their quick and flexible processing, do not need to be preheated and can be easily removed from paint, clothing and skin. Screenfix thus represents the peak of polymer technology for bonding motor vehicle windscreens. This product is available in four curing times, where Screenfix 15 requires only 15 minutes of exposure time thus saving long waiting times for your customers. The variety of drive away times (for vehicles with twin airbags) means there is a Screenfix to suit every situation and budget.

- ✓ Single component adhesive - Apply easily with air gun or hand caulking gun
- ✓ No pre-heating of product - More flexible application temperature range
- ✓ Primer-less system - No time wasted on priming and activation
- ✓ Crash tested to FMVSS 212 - Recognised performances
- ✓ High green strength - Limited, to no clamping required, no time wasted
- ✓ Good dielectric resistance - Suitable for modern glass with integrated aerials
- ✓ Isocyanate free - No health risks, safe to use

| | | |
|--------------------------------------------|-------|-----------|
| Part number: 88003 (Screenfix Zero + Wipe) | 290ml | Cartridge |
| Part number: 88001 (Screenfix Zero) | 400ml | Sausage |
| Part number: 88033 (Screenfix 30 + Wipe) | 290ml | Cartridge |
| Part number: 88031 (Screenfix 30) | 400ml | Sausage |
| Part number: 88093 (Screenfix 90 + Wipe) | 290ml | Cartridge |
| Part number: 88091 (Screenfix 90) | 400ml | Sausage |
| Part number: 88153 (Screenfix 150 + Wipe) | 290ml | Cartridge |
| Part number: 88151 (Screenfix 150) | 400ml | Sausage |



Windscreen



SCREENFIX ZERO







SCREENFIX 30



SCREENFIX 90



SCREENFIX 150

| Driveaway time with 2 airbags | Immediate | 30 minutes | 90 minutes | 150 minutes |
|---------------------------------------------|------------------------------------------------------------------------------------------|---------------------------------------------------------------------------------------------------|-----------------------------------------------------------------------------------------------------|--------------------------------------------------------------------------------------------|
| Viscosity (gunnability at 5 sec-1) | approx 2500 Pa | approx 2000 Pa | approx 1300 Pa | approx 1300 Pa |
| Skin forming time | approx 10 min. | approx 15 min. | approx 15 min. | approx 15 min. |
| Green strength | approx 2000 Pa | approx 600 Pa | approx 600 Pa | approx 300 Pa |
| Also available in sausage containers |  400 ml |  400 ml & 600 ml |  400 ml & 600 ml |  400 ml |

MS-Polymers vs polyurethane adhesives:



KENT SCREENFIX

Polyurethanes

| | | |
|----------------------------------|------------------------------------|--------------------------------------------------------------------------------------------------------------------------------------------------------------------------------------------------------------------------------------------------------------------------------------------------------------------------------------------------------------------------------------------------------------------------------------------------------------------------------|
| Lap shear strength | Approx. 3 to 6 MPa | Approx. 5 to 8 MPa |
| Drive-away time | 0 minutes to 90 minutes | 30 min to 4 hours |
| Costs | Adhesive only and less labour time | Adhesive, primer and more labour time |
| Application process | Primer less and activatorless | Use of a primer or activator |
| Hazard information | None | Contains isocyanates. Isocyanates are potentially dangerous irritants to the eyes and respiratory tract. Frequent exposure can cause severe and permanent allergic reactions. The primer is also hazardous as it contains solvents (highly volatile component) |
| Hazard symbols on label | None | Respiratory hazard  |
| Hazard sentences on label | None for the Screenfix range | Danger – May cause allergy or asthma symptoms or breathing difficulties if inhaled. Wear respiratory protection. Avoid breathing vapours. If experiencing respiratory symptoms: Call a POISON CEN-TER. IF INHALED: Remove person to fresh air and keep comfortable for breathing. Store in a well-ventilated place. Keep cool. Dispose in accordance with local regulations. Contains isocyanates. May produce an allergic reaction. Contains: methylenediphenyl diisocyanate. |

MS PREP

An adhesion promoter for use with KENT MS Polymer windscreen adhesives.

- ✓ Increase bond strength of MS Polymers to wide range of substrates
- ✓ Fast drying (2 minutes) - Decrease time required to change windscreen
- ✓ Easy to use "wash primer" - Cleaner and adhesion promoter in one product

Part number: 83748

100ml

Tin



UREFIX 60

A high performance single part polyurethane adhesive specially developed for direct glazing applications.

- ✓ Tack free time of 10 to 15 minutes - Less clamping
- ✓ High modulus - maintains torsional rigidity of the vehicle
- ✓ 1 hour drive away with double airbag - fast return of vehicle to customer

Part number: 86596

310ml

Cartridge

Part number: 86597

400ml

Sausage



PRIMER BLACK

An adhesion promoter for use with polyurethane windscreen adhesives.

- ✓ Increase bond strength of PU to windscreen - No 'come-backs'
- ✓ Black in colour - Suitable to repair damaged shade bands on glass
- ✓ High bond/join reliability

Part number: 83661

30ml

Tin



SCREEN PREP WIPE

Disposable wipe impregnated with cleaning alcohol.

- ✓ Sufficient to treat one vehicle - Economical, no wastage
- ✓ Supplied in sealed sachet - No drying out

Part number: 34992

Foil Pack



PRIMER BUD

A disposable brush for applying windscreen primers and adhesion promoters to vehicle pinch welds and glass when conducting windscreen and other glass replacement tasks.

- ✓ High quality materials
- ✓ Absorbent bud
- ✓ Low cost and disposable

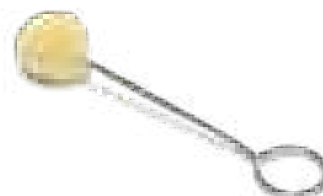

Part number: 86835

Pack of 10

BUTYL WINDSCREEN TAPE

For use in the replacement of older, direct glazed windshields and side windows.

- ✓ Bonds immediately on contact
- ✓ Will not sag or collapse
- ✓ Can also be used for sticking items of trim



Part number: 20130

6.3mm x 4.5m

Roll

Part number: 20125

8mm x 4.5m

Roll

Part number: 20115

9.5mm x 4.5m

Roll

EXCALIBUR DELUXE KIT

Lightweight, powerful, air powered cut-out knife in a comprehensive kit.

The Excalibur is designed to cut through windscreen adhesive quickly and safely. The cutting blade reciprocates within a metal sheath which protects the dashboard, headlining and other trim from damage whilst the cutting operation is underway. The blade is never really exposed because it is covered by the sheath until it enters the adhesive. Supplied complete with the Excalibur Deluxe are 3 sizes of cut-out blades (100mm, 200mm and 300mm) together with the adjustable length sheaths which will remove any glass. The kit comes supplied in a foam lined plastic carry case and includes a pair of safety glasses.

Features and benefits

- ✓ Will quickly and safely remove any glass
- ✓ Extensive kit has everything you need, ready to go
- ✓ Supplied in a sturdy carry case



Part number: E0135

Carry Case

EQUALIZER SERRATED BLADE

Designed for use with the Excalibur Air Powered Cut Out Knife, these blades are made from spring steel and are sharpened with a unique double serration to give fast cutting and long life with a smooth action.

- ✓ Cut fast
- ✓ Long life

| | | |
|--------------------|-------|---------|
| Part number: E0137 | 300mm | 1 piece |
| Part number: E0138 | 200mm | 1 piece |
| Part number: E0139 | 100mm | 1 piece |



EQUALIZER BLADE

Designed for use with the Excalibur Air Powered Cut Out Knife, these blades have rounded edges and special hardening so that they will not bind nor buckle within the sheath.

- ✓ Will not bind or buckle
- ✓ Long life

| | | |
|--------------------|-------|---------|
| Part number: E0140 | 300mm | 1 piece |
| Part number: E0141 | 200mm | 1 piece |
| Part number: E0142 | 100mm | 1 piece |



EQUALIZER SHEATH

A unique and patented design that surrounds the cutting blade allowing only the required depth of cutting edge to be visible at the end of the sheath. Designed for use with the Excalibur Air Powered Cut Out Knife, these sheaths prevent damage occurring to dashboards and other trim.

- ✓ Unique, patented design
- ✓ Prevent damage occurring to dashboards, headlining and other trim

| | | |
|--------------------|-------|---------|
| Part number: E0143 | 300mm | 1 piece |
| Part number: E0144 | 200mm | 1 piece |
| Part number: E0145 | 100mm | 1 piece |



EQUALIZER RAPTOR

Equalizer Raptor is a unique auto glass removal device, easy to maneuver on all types of auto glass.

- ✓ Easy to use - No need to reposition the tool because it doesn't slide off
- ✓ Compatible with fiber wires and metal wires
- ✓ Battery operated - No need to repeatedly pump the vacuum cup



EQUALIZER NINJA DELUXE KIT

A revolutionary auto-glass removal tool that allows you to remove any glass, fast and effortlessly. Kit includes two 19.1mm, three 25.4mm and two 38.1mm blades and comes in a sturdy plastic carry case.

- ✓ Super fast cutting action - Speed up workflow
- ✓ Unique feature - Position blade at 90° angle for cutting in awkward places
- ✓ Handy and convenient - Comes supplied in sturdy case with spare blades

Part number: E0942

Carry Case



PREPMASTER KIT

A comprehensive kit which comes with one Prepmaster, 5 of each size blade to fit it along with a utility knife (with quick-change feature) and a package of 5 utility knife blades.

- ✓ High quality materials and construction - Built to last
- ✓ Supplied in a tough and durable case - Keeps everything together and safe

Part number: E0943

Carry Case



DOOR PANEL CLIP REMOVAL TOOLS

Removal set for every possible panel clip.

- ✓ A tool for every possible panel clip
- ✓ Ergonomically designed - Comfortable to use

Part number: E0203

5 tools



HEAVY DUTY WINDSHIELD STAND

A heavy duty, adjustable windscreen preparation stand with medium density foam around the 25mm diameter tubing that grabs and holds the glass so it cannot move. Designed to last a lifetime.

- ✓ Assembles with just 6 bolts
- ✓ Height adjustable - Versatile and practical
- ✓ Medium Density Foam - 'grabs' the glass

Part number: E0133

1 piece



SUPER SCRAPER KIT

Keeps everything together so it's not lost among the other tools in the tool box. Kit comes with one solid handle Super-Scraper, 10 of each size blade E0104 (12mm wide), E0105 (16mm wide) and E0106 (19mm wide).

- ✓ Supplied in a sturdy and practical case - Convenient
- ✓ Comes with 30 replacement blades in different sizes

Part number: E0207

Case

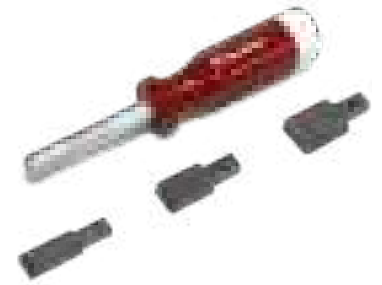

SUPER SCRAPER

The Super-Scraper has a lightweight aluminium shaft with a quick-change collet that lets you change the blade in seconds.

- ✓ Heavy duty plastic handle - Tough and durable
- ✓ Innovative flip-top handle lid that stores extra 12mm blades
- ✓ Supplied with 5 replacement blades (12mm) - Economical and convenient

Part number: E0103

25cm long

1 piece



SUPER SCRAPER REPLACEMENT BLADES

Stainless steel blades in 3 widths designed specifically for the Super Scraper.

- ✓ Premium quality
- ✓ Various sizes/widths to suit the task in hand

Part number: E0104

12mm

Pack of 5

Part number: E0105

16mm

Pack of 5

Part number: E0106

19mm

Pack of 5



WIDE PINCHWELD SCRAPER

Razor blade scraper for removing cured adhesive.

- ✓ Blades are easily replaced and no sharpening is needed
- ✓ Supplied with safety cover to keep the blade sharp and safe

Part number: E0157

1 piece



EQUALIZER VIPER BLADES

Windscreen cut-out knife blades. Made of flexible steel so they will flex to 'warn' the user before they break. They are flat on one side so they will ride against the glass and cut out the windscreen adhesive at the point of least resistance.

- ✓ Fit every oscillating tool on the market - Versatile
- ✓ Flexible steel - User will know if they are about to break

| | | |
|----------------------------------------------------|---------------|---------|
| Part number: E0148 (Powered Cold Knife Blade) | 25mm (1") | 1 piece |
| Part number: E0149 (Powered Cold Knife Blade) | 38mm (1 1/2") | 1 piece |
| Part number: E0154 (Straight Offset Cutting Blade) | 89mm (3 1/2") | 1 piece |
| Part number: E0153 (Curved Offset Cutting Blade) | 53mm (2 1/8") | 1 piece |



Z COLD KNIFE BLADES

The cutting edge of the blade is ground to a greater angle than other cold knife blades, This reduces the blade resistance and effort required to cut the windscreen adhesive, A blade that has the ability to resist breaking, lasts longer and keeps a sharp edge.

- ✓ Remain flexible and retain their sharpness much longer
- ✓ Cutting is effortless

| | | |
|--------------------|------|-----------|
| Part number: E0114 | 19mm | Pack of 5 |
| Part number: E0115 | 25mm | Pack of 5 |
| Part number: E0116 | 38mm | Pack of 5 |



COINED Z BLADES

Coined Z blades are thinned before they are hardened so there is no need to grind them thinner. This grinding action is carefully controlled to leave a sharp cutting edge only 88 thousandths of a mm thick.

- ✓ No need to grind the blades
- ✓ Ultra sharp cutting edge - Only 88 thousands of a mm thick

| | | |
|--------------------|------|-----------|
| Part number: E0117 | 19mm | Pack of 5 |
| Part number: E0118 | 25mm | Pack of 5 |
| Part number: E0119 | 38mm | Pack of 5 |



SQUIRE WIRE AUTO GLASS CUT-OUT WIRE

The cutting ability of Squire Wire is better than traditional round wire. As the Squire Wire has four sharp edges at each corner it will ensure a faster and easier cut.

- ✓ Saves time - Required less effort
- ✓ Better than traditional round wire



Part number: E0209 22m Roll

BRAIDED WIRE

Three-strand twisted and coated cutting wire.

- ✓ Superior quality - Work fast and efficient
- ✓ Economical - Large coil



Part number: 34014 22.5m Coil

TIGHTWIRE AUTO GLASS CUT-OUT WIRE

Composed of three super-strong stainless steel wires braided to form one wire, Tightwire is anodised to give a smooth finish and a distinctive gold colour.

- ✓ Diameter 0.5mm - Perfect for quick, effortless cutting
- ✓ Less chance of breaking compared to standard piano wire



Part number: E0107 22m Roll

PREMIUM QUALITY DAUBERS

High quality wool daubers, made of a thick wool tuft that is held tightly in the center with a strong wire.

- ✓ Premium quality
- ✓ Economical bulk pack
- ✓ Speed up workflow



Part number: E0201 Pack of 100

VIEWMASTER KIT

Repairs any type of chip/break or crack up to 10cm long. 1ml of resin in the syringe will be sufficient for 5 to 8 repairs. The syringe packaging will give extra UV protection to the resin while in the syringe. The complete kit has everything you need including a special wash primer to clean out an old break that has water in it.

Contents of the kit:

Jig, carbide marking tool, drill hole punch, UV lamp, vacuum pump, clear plastic suction cup, hose with cylinder adapter, polishing disc, 12V drill, mirror with suction cup, pen light, battery attachment with heater, bulls eye maker, pressure tool (to open up a break), vertical adapter (for buses or trucks), carbide drill bits, special adhesive tape (for long cracks), scraping blades, UV spare bulb and detailed instructions.

Chemical contents:

Filling Resin, Finishing Resin, Polishing Liquid, Vacuum Gel and Primer.

Features and benefits

- ✓ Resin is silane based - Ensures excellent adhesion
- ✓ Resin is less viscous than other products - Excellent durability and resistance
- ✓ Finishing resin & filling resin are separate - More flexibility, durable seal
- ✓ Viewmaster system removes air from repair - Better quality repair

| | | |
|------------------------------------------------------|------|------------|
| Part number: 84700 (Complete Kit) | | Carry Case |
| Part number: 84701 (Filling Resin) | 1ml | Bottle |
| Part number: 84702 (Finishing Resin) | 2ml | Bottle |
| Part number: 84703 (Polishing Liquid) | 80ml | Bottle |
| Part number: 84704 (Vacuum Gel) | 60ml | Bottle |
| Part number: 84705 (Primer) | 50ml | Bottle |
| Part number: 84706 (Finishing Foils) | | Pack of 5 |
| Part number: 84707 (Carbide Drill Bits) | 1mm | Pack of 6 |
| Part number: 84709 (Scraping Blades) | | Pack of 5 |
| Part number: 84710 (6W UV Spare Tube) | | 1 piece |
| Part number: 84711 (UV Protective Foils) | | Pack of 3 |
| Part number: 84712 (Washing Cylinder Red) | | 1 piece |
| Part number: 84713 (Tool Holder) | | 1 piece |
| Part number: 84714 (Carbide Marking Tool) | | 1 piece |
| Part number: 84716 (12V 6W UV Lamp) | | 1 piece |
| Part number: 84718 (Polishing Discs) | | 1 piece |
| Part number: 84719 (12V Drill) | | 1 piece |
| Part number: 84720 (Plastic Mirror with Suction Cup) | | 1 piece |





KENT (United Kingdom) Ltd.

Forsyth House, Pitreavie Business Park, Dunfermline, Fife, KY11 8US
T: 0800 136925 - E: kentinfo.uk@kenteurope.com

www.kenteurope.com